

SMV Series

Super Miniature Variable Power Transmitters

With Digital Hybrid Wireless® Technology

US Patent 7,225,135



- SMQV** Dual Battery Model
- SMV** Single Battery Model
- RM** Remote Control
- RM2** Remote Control

Fill in for your records:

Serial Number:

Purchase Date:

Introduction

The SM Series variable power transmitters are the product of many years of engineering and experience in professional audio markets. The unique design provides several distinct features for professional applications:

- Selectable output power to maximize battery life or operating range as needed
- Superb, compandor-free audio quality
- Ultra-lightweight, corrosion resistant housing
- Water resistant seals for use in damp environments
- Programmable compatibility modes for use with a wide variety of different receivers

The Digital Hybrid Wireless® design (US Patent 7,225,135) combines 24-bit digital audio with analog FM resulting in a system that has the same operating range as analog systems, the same spectral efficiency as analog systems, the same long battery life as analog systems, plus the excellent audio fidelity typical of pure digital systems.

The SM Series transmitters feature the unique servo bias input circuitry with a standard TA5M type input jack for use with electret lavalier mics, dynamic mics, or line level signals. A water resistant control panel with LCD, membrane switches and multi-color LEDs make input gain adjustments, frequency and compatibility mode selection quick and accurate, without having to view the receiver. The battery compartment accepts AA lithium or rechargeable batteries. The housings are machined from solid aluminum blocks to provide an extremely lightweight and rugged package. A special non-corrosive finish resists salt water exposure and perspiration in extreme environments.

The DSP-based design works with all Digital Hybrid receivers, and is backward compatible for use with Lectrosonics 200 Series, 100 Series, IFB receivers and some other brands of analog wireless receivers.

Table of Contents

Introduction	2
General Technical Description	4
Controls and Functions	6
LCD Screen	6
Power LED	6
Power LED Off Feature	6
Audio Input Jack.....	6
AUDIO Button	6
FREQ Button.....	6
Up/Down Arrows	6
Battery and Battery Eliminator Installation	7
Attaching and Removing the Microphone	7
Operating Instructions	8
Power Up and Boot Sequence	8
Power Down	8
Standby Mode.....	8
LCD Backlight Settings	8
Selecting the Compatibility Mode and Output Power	8
Audio Screen	9
Frequency Screen.....	9
Lock/Unlock Screen	9
Remote Control Operation.....	9
Configuring for Power Restore	10
Setting Transmitter Operating Frequency.....	10
Adjusting Audio Level (Gain).....	10
Set Up in 100 kHz Mode	10
Set Up in 25 kHz Mode	10
Locking or Unlocking the Controls	11
5-Pin Input Jack Wiring	11
Line Level Signals	12
Installing the Connector:	12
Microphone RF Bypassing.....	12
Microphone Cable Termination for Non-Lectrosomics Microphones	13
Wiring Hookups for Different Sources.....	14
Compatible Wiring for Both Servo Bias Inputs and Earlier Transmitters:	14
Simple Wiring - Can ONLY be used with Servo Bias Inputs:.....	14
Silver Paste on SM Series Transmitter Thumbscrews	15
RM Remote Control	16
Powering the RM on and off.....	16
RM Functions and Operation	16
Operating Notes.....	17
RM2 Remote Control	17
LectroRM	18
Straight Whip Antennas	19
Accessories for single battery models:	20
Accessories for dual battery models:	20
Accessories for Both Models	21
Troubleshooting	22
RM Troubleshooting	23
Specifications and Features	24
Service and Repair	25
Returning Units for Repair	25

General Technical Description

Servo Bias Input

The voltage and current requirements of the wide variety of electret microphones used in professional applications has caused confusion and compromises in the wiring needed for wireless transmitters. To address this problem, the unique Servo Bias input circuit provides an automatically regulated voltage over a very wide range of current for compatibility with all microphones.

Digital Hybrid Wireless® Technology

All wireless links suffer from channel noise to some degree, and all wireless microphone systems seek to minimize the impact of that noise on the desired signal. Conventional analog systems use companders for enhanced dynamic range, at the cost of subtle artifacts (typically “pumping” and “breathing”). Wholly digital systems defeat the noise by sending the audio information in digital form, at the cost of some combination of power, bandwidth and resistance to interference.

Digital Hybrid systems overcome channel noise in a dramatically new way, digitally encoding the audio in the transmitter and decoding it in the receiver, yet still sending the encoded information via an analog FM wireless link. This proprietary algorithm is not a digital implementation of an analog compandor but a technique that can be accomplished only in the digital domain, even though the inputs and outputs are analog.

Because it uses an analog FM link, the Digital Hybrid system enjoys all the benefits of conventional FM wireless systems and it does away with the analog compandor and its artifacts.

No Pre-Emphasis/De-Emphasis

The Digital Hybrid design results in a signal-to-noise ratio high enough to preclude the need for conventional pre-emphasis (HF boost) in the transmitter and de-emphasis (HF roll off) in the receiver. This eliminates the potential for distortion of signals with abundant high-frequency information.

Low Frequency Roll-Off

The low frequency roll-off can be set for a 3 dB down point at 35, 50, 70, 100, 120 and 150 Hz to control subsonic and very low frequency audio content in the audio. The actual roll-off frequency will vary slightly depending upon the low frequency response of the microphone.

Excessive low frequency content can drive the transmitter into limiting, or in the case of high level sound systems, can even cause damage to loudspeaker systems. The roll-off is normally adjusted by ear while listening as the system is operating.

Input Limiter

A DSP-controlled analog audio limiter is employed before the A-D converter. The limiter has a range of more than 30 dB for excellent overload protection. A dual release envelope makes the limiter acoustically transparent while maintaining low distortion. It can be thought of as two limiters in series, a fast attack and release limiter followed by a slow attack and release limiter. The limiter recovers quickly from brief transients, with no audible side effects, and also recovers slowly from sustained high levels to keep audio distortion low while preserving short term dynamics.

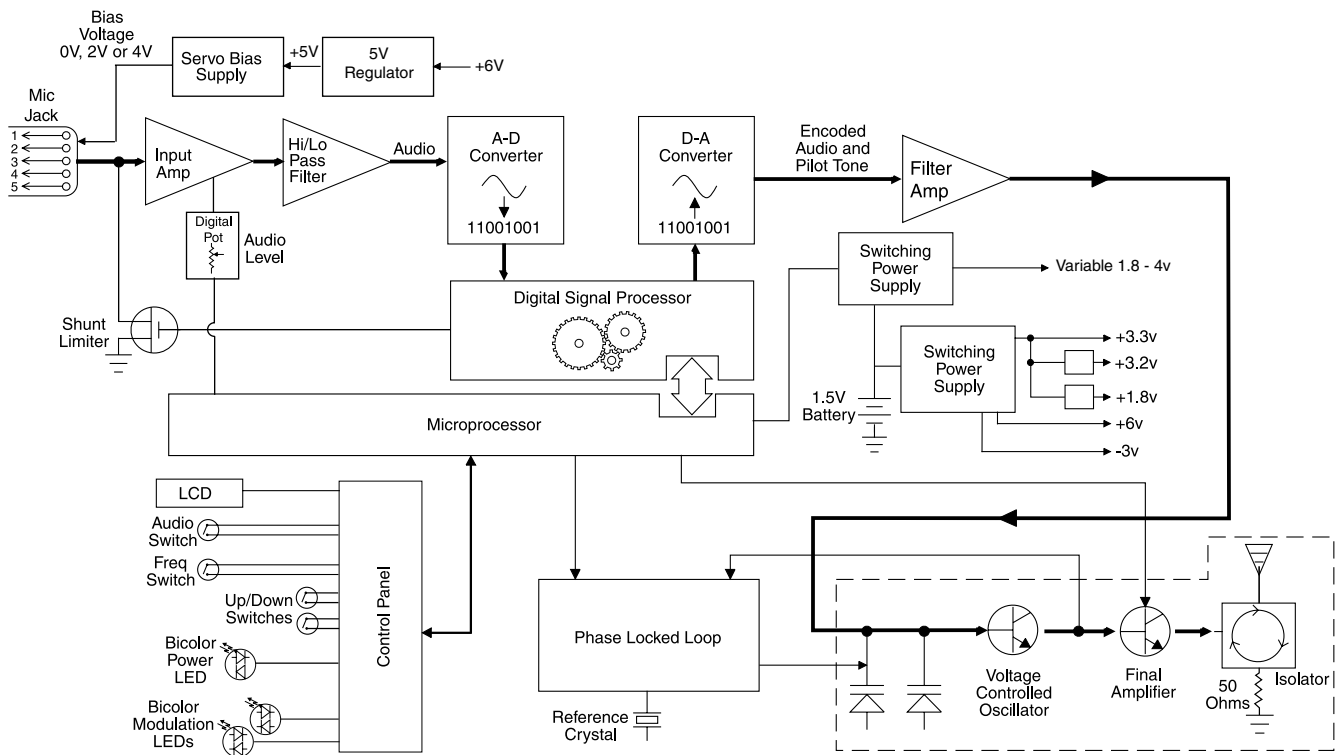

Signal Encoding and Pilot Tone

In addition to controlling the limiter, the DSP also encodes the digitized audio from the A/D converter and adds an ultrasonic pilot tone to control the squelch in the receiver. A pilot tone squelch system provides a reliable method of keeping a receiver output muted (audio mute) even in the presence of significant interference. When the system is operating in the hybrid mode, a different pilot tone frequency is generated for each carrier frequency to prevent inadvertent squelch problems in multi-channel systems.

Microprocessor Control

A microprocessor monitors user command inputs from the control panel buttons and numerous other internal signals. It works intimately with the DSP to ensure the audio is encoded according to the selected Compatibility Mode and that the correct pilot tone is added to the encoded signal.

Compatibility Modes

SM transmitters are designed to operate with Lectrosonics Digital Hybrid receivers and will yield the best performance when doing so, however, due to the flexibility of digital signal processing, the transmitter can also operate in various compatibility modes for use with Lectrosonics 200 Series, Lectrosonics 100 Series, IFB and certain non-Lectrosonics receivers. Contact the Lectrosonics sales department for more information about non-Lectrosonics receivers.

Control Panel

The control panel includes four membrane switches and an LCD screen to adjust the operational settings. Multi-color LEDs are used to indicate audio signal levels for accurate gain adjustment and for battery status.

Wide-Band Deviation

± 75 kHz deviation improves the signal to noise ratio and audio dynamic range of a wireless system dramatically, compared to other designs that use ± 30 kHz to 40 kHz deviation. Wide deviation combined with a high powered transmitters makes a significant improvement in signal to noise ratio and operating range.

Variable Power Output

This advanced feature allows the operator to optimize the transmitter for maximum battery life, or for maximum operating range. Power output is selected using the LCD in a setup mode while the RF output of the transmitter is turned off.

Battery Options and Operating Time

Switching power supplies convert regulated battery voltages to operate various circuit stages with maximum efficiency.

The firmware “remembers” the power status when a battery fails, so the transmitter will be turned on automatically when the battery is replaced and the previous settings will be enabled.

Frequency Blocks

Lectrosonics established a “block” numbering system years ago to organize the range of frequencies available from the low end at 470 MHz band to the upper end at 952 MHz. Each block (except 944) includes 256 frequencies in 100 kHz steps, which is the maximum switching range of the transmitters. Block 944 is a special band between 944 and 952 MHz.

Circulator/Isolator

The RF output circuit includes a one way circulator/isolator using a magnetically polarized ferrite. This device greatly reduces RF intermodulation produced when multiple transmitters are used in close proximity to one another (several feet apart). The isolator also provides additional RF output stage protection against static shock.

Controls and Functions

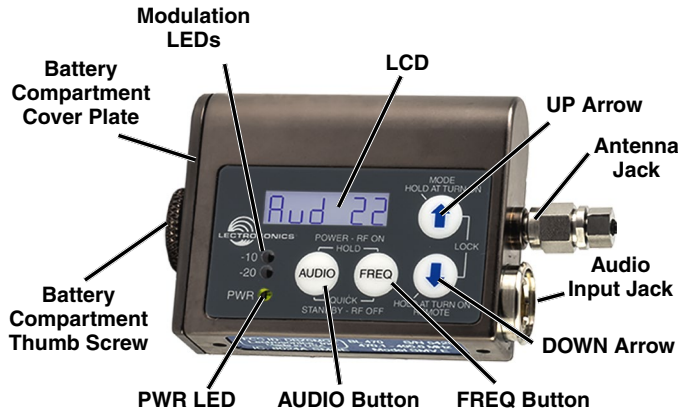

LCD Screen

The LCD is a numeric-type Liquid Crystal Display with screens for adjusting power, frequency, audio level and low frequency audio roll-off. The transmitter can be powered up with or without the RF output turned on. A countdown appears in the LCD when powering on and off, allowing the transmitter to be turned on without RF for adjustments, and to prevent accidentally turning it off with momentary button presses.

Power LED

The PWR LED glows green when the battery is good. The color changes to red when there is about 30 minutes of operation left with the recommended lithium battery. When the LED begins to blink red, there are only a few minutes of life.

The exact point at which the LED turns red will vary with battery brand and condition, temperature and current drain. The LED is intended to simply catch your attention, not to be an exact indicator of remaining time.

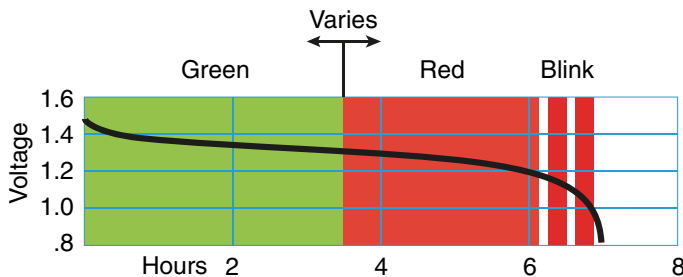

A weak battery will sometimes cause the PWR LED to glow green immediately after the transmitter is turned on, but will soon discharge to the point where the LED will turn red or the unit will turn off completely.

Power LED Off Feature

In normal operating mode, the DOWN and UP Arrow buttons may be used to turn the PWR LED indicators off and on. This setting does not persist through a power cycle nor does it affect the LCD backlight.

Audio Input Jack

The Servo Bias input circuitry accommodates virtually every lavalier, handheld or shotgun microphone available, plus line level signals.

Battery Compartment and Thumb Screw

The large knurled thumbscrew is used to release or secure the Battery Compartment Cover Plate.

Modulation LEDs

Proper input gain adjustment is critical to ensure the best audio quality. Two bicolor LEDs will glow either red or green to accurately indicate modulation levels. The input circuitry includes a wide range DSP controlled limiter to prevent distortion at high input levels.

It is important to set the gain (audio level) high enough to achieve full modulation during louder peaks in the audio. The limiter can handle over 30 dB of level above full modulation, so with an optimum setting, the LEDs will flash red during use. If the LEDs never flash red, the gain is too low. In the table below, +0 dB indicates full modulation.

Signal Level	-20 LED	-10 LED
Less than -20 dB	● Off	● Off
-20 dB to -10 dB	● Green	● Off
-10 dB to +0 dB	● Green	● Green
+0 dB to +10 dB	● Red	● Green
Greater than +10 db	● Red	● Red

AUDIO Button

The AUDIO button is used to display the audio level and low frequency roll-off settings. The UP and DOWN arrows adjust the values.

The AUDIO button is also used with the FREQ button to enter standby mode and to power the transmitter on or off.

FREQ Button

The FREQ Button displays the selected operating frequency and toggles the LCD between displaying the actual operating frequency in MHz and a two-digit hexadecimal number that corresponds to the equivalent Lectrosonics Frequency Switch Setting.

Up/Down Arrows

The Up and Down arrow buttons are used to select the values on the various setup screens and to lock out the control panel.

Antenna

The transmitter uses a whip antenna with a flexible woven, galvanized steel mesh cable and a standard SMA connector.

Battery and Battery Eliminator Installation

Note: Standard zinc-carbon batteries marked “heavy-duty” or “long-lasting” are not adequate.

The battery status circuitry is designed for the voltage drop over the life of lithium batteries.

To install new batteries:

1. Turn the Battery Cover Plate Thumbscrew counter-clockwise a few turns until the door will rotate.
2. Insert the new batteries into the housing. **The positive (+) battery terminal goes into the transmitter first.**
3. Align the Battery Cover Plate and tighten the Battery Cover Plate Thumbscrew.



To install the battery eliminator, loosen the thumbscrew completely and remove the battery door. Insert the battery eliminator and tighten the thumbscrew.



Gore - Tex Registered trademark of W. L. Gore and Associates

Attaching and Removing the Microphone

The flexible sleeve over the 5-pin plug on the microphone helps prevent dust and moisture from getting into the input jack. The flange around the rim of the connector on the transmitter helps retain the sleeve after it is installed and

The following procedure simplifies the attachment and removal of the microphone to assure the sleeve is seated securely.

Align the pins on the plug and jack and insert the connector.



If the sleeve is pulled down and covering the connector, squeeze the end of the sleeve so you can feel the connector inside and press it into the jack until it latches.



Pinch and squeeze the sleeve near the flange and work it down with a kneading motion over the flange all the way around until it stays in place flush with the housing. Pull on the connector to make sure it is firmly latched.



To remove the connector, pull the sleeve back to expose the black release button. Press the button to unlatch the plug.

Operating Instructions

Power Up and Boot Sequence

- 1) Ensure that good batteries are installed in the unit.
- 2) Simultaneously press and hold the AUDIO and FREQ buttons until the Power On Boot Sequence is initiated.



The count will progress from 1 through 3 and the unit will then power up with the RF output

turned on. During this turn on sequence, the modulation and power LEDs all glow red, then green, and then revert to normal operation.

The LCD displays a bootup sequence which consists of four screens:

Company Name:	Lectro
Frequency Block (bXX) and Firmware Version (rX.X):	b21r1.1 (typ)
Power Level	Pr 250
Compatibility Mode:	CP 400 (typ)
Audio:	Aud 12 (typ)

Power Down



Initial Power Off
Timer Screen

- 1) Simultaneously press and hold the AUDIO and FREQ buttons while observing that the word “Off” appears in the LCD along with a counter.
- 2) When the counter reaches “0”, the unit turns off.

Note: If the AUDIO and FREQ buttons are released before the LCD goes blank at the end of the countdown, the unit will not turn off. Instead, it will stay energized and the display will return to the previous screen.

Standby Mode



Standby Screen

With the power turned off, pressing the AUDIO and FREQ buttons briefly places the unit in Standby Mode. In this mode the RF output is

turned off so all setup adjustments can be made without interfering with other systems operating in the same location. The screen displays “rf OFF” to remind the user that the unit is not transmitting.

While the unit is in the standby mode, access the setup screens using the AUDIO and FREQ buttons and make adjustments using the Up and Down arrows.

LCD Backlight Settings

The LCD backlight can be set to turn off after either 5 minutes or 30 seconds, or stay on continuously.

Hold the UP arrow in while powering up the unit to enter the setup screen. Press the AUDIO button repeatedly to step through the setup items to reach the backlight settings screen. Use the UP or DOWN arrow button to select the desired setting.



Selecting Step Size mode

Hold the UP arrow in while powering up the unit to enter the setup screen. Press the AUDIO button repeatedly to step through the setup items to reach the Step Size Mode screen. Use the UP or DOWN arrow button to select the desired setting.



Selecting the Compatibility Mode and Output Power



400 Series or Digital
Hybrid Wireless™
compatibility mode

The transmitter will work with 200 Series, 100 Series and IFB analog receivers, plus some other analog wireless receivers in addition to the native digital hybrid mode.



Power setting

Note: The unit automatically enters the Standby Mode when selecting compatibility.

- 1) Set the receiver’s audio controls to minimum.
- 2) From a power off condition, hold down the Up arrow, then simultaneously press the AUDIO and FREQ buttons.
- 3) Press either AUDIO or FREQ button to select the compatibility screen and use the Up and Down arrows to select the desired mode.

The following Compatibility Modes are available:

- 100 Series mode: CP 100
- 200 Series mode: CP 200
- Mode 3 (contact the factory for details): CP 3
- 400 Series mode: CP 400
- IFB Series mode: CP IFB
- Mode 6 (contact the factory for details): CP 6

- 4) Press either AUDIO or FREQ button to select the power setting screen and use the Up and Down

down arrows to select the desired level of power.

- 5) Simultaneously press the AUDIO and FREQ buttons to exit this mode and turn off the power.

Audio Screen

Aud 12

The Audio screen is used to adjust input gain from 0 to +44 dB, and the low frequency roll-off from 35 to 150 Hz.

LF 35

Repeatedly pressing the AUDIO button toggles back and forth between the two

displays. Press and hold the AUDIO button and use the Up and Down arrows to make adjustments.

Frequency Screen

644.400

The Frequency Screen displays the operating frequency in MHz or as a two-digit hexadecimal number that corresponds to the equivalent Lectrosonics Frequency Switch Setting. Repeatedly pressing the

CH 20

FREQ button toggles between the two displays. Press and hold the FREQ button and use the Up and Down arrows to select the frequency.

Lock/Unlock Screen

Loc

Simultaneously pressing and holding both the Up and Down arrow buttons during normal operation starts the Lock timer. The timer starts at three and counts down to zero. When the timer

unLoc 1

reaches zero, the transmitter's controls are locked.

With the controls locked, the AUDIO and FREQ buttons can still be used to display current settings. Any attempt to change a setting by pressing either the Up or Down arrow button will result in an on-screen *Loc* reminder that the controls are locked. Remove the batteries to unlock the control panel.

Important: *Once the transmitter is locked, it cannot be unlocked or powered off using the buttons. The only ways to unlock a locked transmitter are to remove the battery or unlock it via the RM remote control.*

Remote Control Operation

rc on

The transmitters can be configured to respond to signals from the RM remote control unit or to ignore them. This setting is accessed by holding down the Down arrow button while powering the transmitter on.

rc off

Remote Control Screens

Use the arrow keys to toggle between "rc on" (remote

control on) and "rc off" (remote control off). The default setting is "rc on."

If a remote control signal is detected but the transmitter is set to "rc off", the message "rc off" will be displayed briefly on the transmitter's LCD, to confirm that a valid signal was received, but that the transmitter is not configured to respond to it.

Remote functions available are:

- Tx Input Gain
- Sleep/Unsleep
- Lock/Unlock
- Frequency
- Tuning in 25 kHz steps
- Changing the low frequency roll-off setting
- Turning on/off the PWR and Audio LEDs
- Gain up/down functions

In sleep mode, the transmitter uses only 20% of the normal amount of battery drain. Sleep mode can only be invoked with the remote control, and can only be revoked with the remote control or by removing the battery. When in the sleep mode, the PWR LED blinks green every few seconds to indicate that the transmitter is asleep and not turned off.

The RM is not included with SM Series transmitters. Several "Dweedle tones" can also be downloaded from the web site at:

<http://www.lectrosonics.com/hybrid/rm/rm.html>

The dweedle tones can be played back through an MP3 player, PDA, etc., and in most cases, will even work with walkie talkies. The tones will not work through the loudspeakers of a sound system because the reflections and reverberation in the room will alter the tones.

Configuring for Power Restore



Power Restore Screens

When using external power source through a battery eliminator, Power Restore will return your transmitter to settings it had before it was powered off. This eliminates the need to power on through the unit itself.

- 1) Press and hold the Down Arrow Button then power on the transmitter by pressing the Audio and Freq buttons simultaneously.
- 2) The LCD will display the status, either “rc ON” or “rc OFF.” Press “AUDIO” or “FREQ” key to scroll to the “PbAc setup screen”
 - PbAc 1 for power restore ON
 - PbAc 0 for power restore OFF
- 3) When power restore is set to ON, the unit will turn on whenever power is present at the battery terminals until the power is manually turned off with the control panel switches.

NOTE: The firmware “remembers” the power status when a battery fails, so the transmitter will be turned on automatically when the battery is replaced and the previous settings will be enabled. Power Up and Boot Sequence

Setting Transmitter Operating Frequency



Frequency displayed in MHz



Frequency displayed as two-digit hexadecimal number

The frequency can be displayed either in MHz or as a two-digit hexadecimal number and can be set in the Standby Mode or when the transmitter is powered up. The hexadecimal numbering system is unique to Lectrosonics where two alphanumeric characters correspond to the left and right switch settings on

earlier analog transmitters that had mechanical rotary switches to adjust frequency.

- 1) Press the FREQ button to select either the MHZ screen or the hexadecimal screen.
- 2) While holding the FREQ button, use the Up or Down arrow buttons to move the operating frequency up or down in 100 kHz increments from the current setting.

Note: The operating frequency displayed on the LCD wraps as it reaches the upper or lower end of its range.

Most Lectrosonics receivers with an LCD interface indicate the operating frequency both in MHz and as a two digit hexadecimal number. In many cases, it is more convenient to use the two character hexadecimal numbers rather than the six character frequency in MHz.

Set Up in 100 kHz Mode



The Frequency Screen displays the operating frequency in MHz or as a two-digit hexadecimal number that corresponds to the equivalent Lectrosonics Frequency Switch Setting.

The example of the two-digit

display shown here indicates **CH** (channel) and **2C** as the frequency. Repeatedly pressing the FREQ button toggles between the two displays. Press and hold the FREQ button and use the Up and Down arrows to select the frequency.

Set Up in 25 kHz Mode

The hexadecimal display in the 25 kHz mode will appear with a decimal suffix to indicate the 25 kHz steps.



644.400 MHz



644.425 MHz



644.450 MHz



644.475 MHz

Adjusting the Low Frequency Roll-off

Repeatedly press the AUDIO button until the LF roll-off adjustment screen appears. Then press and hold the AUDIO button while selecting the desired roll-off frequency with the UP and DOWN arrows.



The roll-off frequency can be set to 35, 50, 70, 100, 120 and 150 Hz.

Adjusting Audio Level (Gain)

The control panel Modulation LEDs indicate the audio level and limiter activity. Once set, the transmitter’s audio level setting **should not** be used to control the volume of your sound system or recorder levels. This gain adjustment matches the transmitter gain with the microphone’s output level, the user’s voice level and the position of the microphone. The audio input level (gain) is adjusted with the unit in the Standby Mode or while powered up while observing the LEDs.

It is desirable to set the gain so that some limiting occurs on louder peaks. The limiter is very transparent and its effect is not audible until the system is close to overload. In other words, don’t be shy about turning up the gain.

It is actually a good idea to turn the gain up to maximum and listen for distortion or compression to get a feel for how much headroom is available.

Signal Level	-20 LED	-10 LED
Less than -20 dB	● Off	● Off
-20 dB to -10 dB	● Green	● Off
-10 dB to +0 dB	● Green	● Green
+0 dB to +10 dB	● Red	● Green
Greater than +10 db	● Red	● Red

Note: Different voices will usually require different gain settings, so check this adjustment as each new person uses the system. If several different people will be using the transmitter and there is not time to make the adjustment for each individual, adjust it for the loudest voice.

- 1) With the transmitter powered off, plug in the microphone and make sure the connector is firmly seated.

Warning: If the systems is powered up while connected to a live sound system, be careful to turn the sound system level down first or severe feedback can occur.

- 2) Place the transmitter in Standby Mode or turn it on for normal use.
- 3) Position the microphone in the location where it will be used in actual operation.
- 4) Observe the Modulation LEDs while speaking or singing into the microphone at the same voice level that will be used during operation. While holding the AUDIO button, press the UP or DOWN arrow buttons until the both the -20 and -10 LEDs glow green, with the -20 LED occasionally flickering red. This will maximize the signal to noise ratio of the system with full modulation and provide subtle limiting to prevent overload and audible compression.
- 5) If the unit was set up in Standby Mode, it will be necessary to turn the transmitter off, then power it up again in normal operation so the RF output will be on. Then the other components in the sound or recording system can be adjusted.

Locking or Unlocking the Controls



Control Panel Locked

The Lock mode protects the transmitter from accidental changes to its settings.

Simultaneously press both the Up and Down arrow

buttons to start the countdown timer. When the timer reaches zero, "Loc" is displayed and the controls are locked. Settings can be reviewed but not changed.

Once the transmitter is locked, it cannot be unlocked or powered off using the buttons. The only ways to unlock a locked transmitter are to remove the battery or unlock it using the remote control. The remote control will work only if the transmitter was previously configured to respond to the remote control. The unit will always power up in "unlocked" mode.

5-Pin Input Jack Wiring

The wiring diagrams included in this section represent the basic wiring necessary for the most common types of microphones and other audio inputs. Some microphones may require extra jumpers or a slight variation on the diagrams shown.

It is virtually impossible to keep completely up to date on changes that other manufacturers make to their products, thus you may encounter a microphone that differs from these instructions. If this occurs please call our toll-free number listed under Service and Repair in this manual or visit our web site at:

www.lectrosonics.com

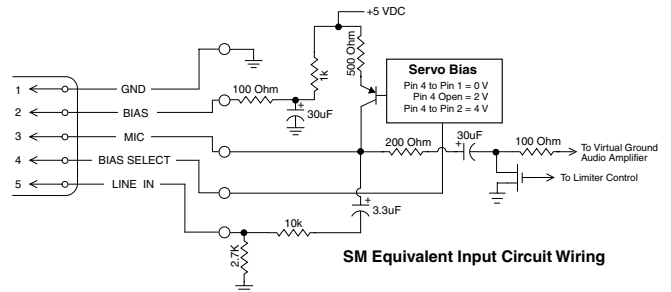

Audio input jack wiring:

- PIN 1** Shield (ground) for positive biased electret lavaliere microphones. Shield (ground) for dynamic microphones and line level inputs.
- PIN 2** Bias voltage source for positive biased electret lavaliere microphones.
- PIN 3** Low impedance microphone level input for dynamic microphones. Also accepts hand-held electret microphones provided the microphone has its own built-in battery.
- PIN 4** Bias voltage selector for Pin 3. Pin 3 voltage (0, 2 or 4 volts) depends on Pin 4 connection.
 - Pin 4 tied to Pin 1: 0 V
 - Pin 4 Open: 2 V
 - Pin 4 to Pin 2: 4 V
- PIN 5** High impedance, line level input for tape decks, mixer outputs, musical instruments, etc.

Installing the Connector:

- 1) If necessary, remove old connector from microphone cable.
- 2) Slide Rubber Boot onto microphone cable with the large end facing away from the microphone. (See illustration above.)
- 3) If necessary, slide the 1/8-inch black shrink tubing onto the microphone cable. (This tubing is needed for some cables to ensure the cable fits snugly in the rubber boot.)
- 4) Use the resistors and connector included with this kit to configure the TA5F to your particular microphone. (See Wiring Diagrams below.) A length of .065 OD clear tubing is included if insulating the resistor leads or shield wire is necessary. (Remove rubber strain relief from connector backshell by pulling it out of the backshell.)
- 5) Slide the Strain Relief over the TA5F Insert and crimp as shown to the right. Then insert the TA5F Insert and Strain Relief in the TA5F Latchlock. Screw the TA5F Flex Relief onto the TA5F Latchlock.
- 6) If needed, position and shrink the 1/8-inch shrink tubing on the microphone cable, then slide the Rubber Boot down over the TA5F connector.

Line Level Signals

The normal hookup for line level signals is: Signal Hot to pin 5, Signal Gnd to pin 1 and pin 4 jumped to pin 1. This allows signal levels up to 3V RMS to be applied without limiting.

If more headroom is needed, insert a 20 k resistor in series with pin 5. Put this resistor inside the TA5F connector to minimize noise pickup.

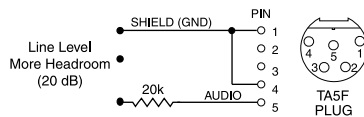
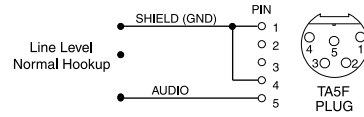

Microphone RF Bypassing

When used on a wireless transmitter, the microphone element is in the proximity of the RF coming from the transmitter. The nature of electret microphones makes them sensitive to RF, which can cause problems with the microphone/transmitter compatibility. If the electret microphone is not designed properly for use with wireless transmitters, it may be necessary to install a chip capacitor in the mic capsule or connector to block the RF from entering the electret capsule.

Some mics require RF protection to keep the radio signal from affecting the capsule, even though the transmitter input circuitry is already RF bypassed (see schematic diagram).

If the mic is wired as directed, and you are having difficulty with squealing, high noise, or poor frequency response, RF is likely to be the cause.

The best RF protection is accomplished by installing RF bypass capacitors at the mic capsule. If this is not possible, or if you are still having problems, capacitors can be installed on the mic pins inside the TA5F connector housing.

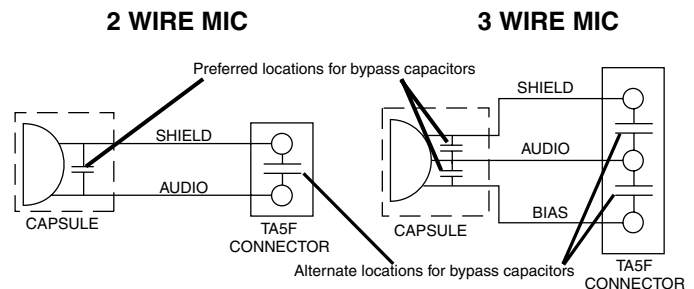

Install the capacitors as follows: Use 330 pF capacitors. Capacitors are available from Lectrosonics. Please specify the part number for the desired lead style.

- Leaded capacitors: P/N 15117
- Leadless capacitors: P/N SCC330P

All Lectrosonics lavalier mics are already bypassed and do not need any additional capacitors installed for proper operation.

Microphone Cable Termination for Non-Lectrosonics Microphones

TA5F Connector Assembly

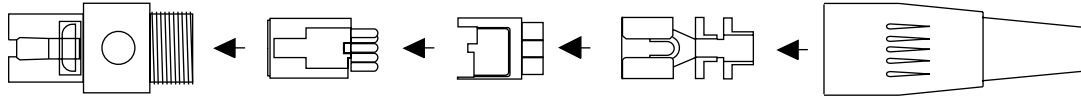

Mic Cord Stripping Instructions

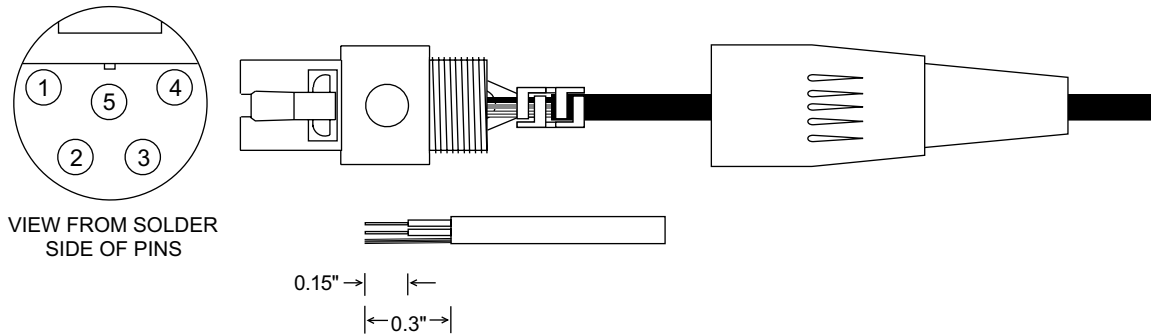

Crimping to Shield and Insulation

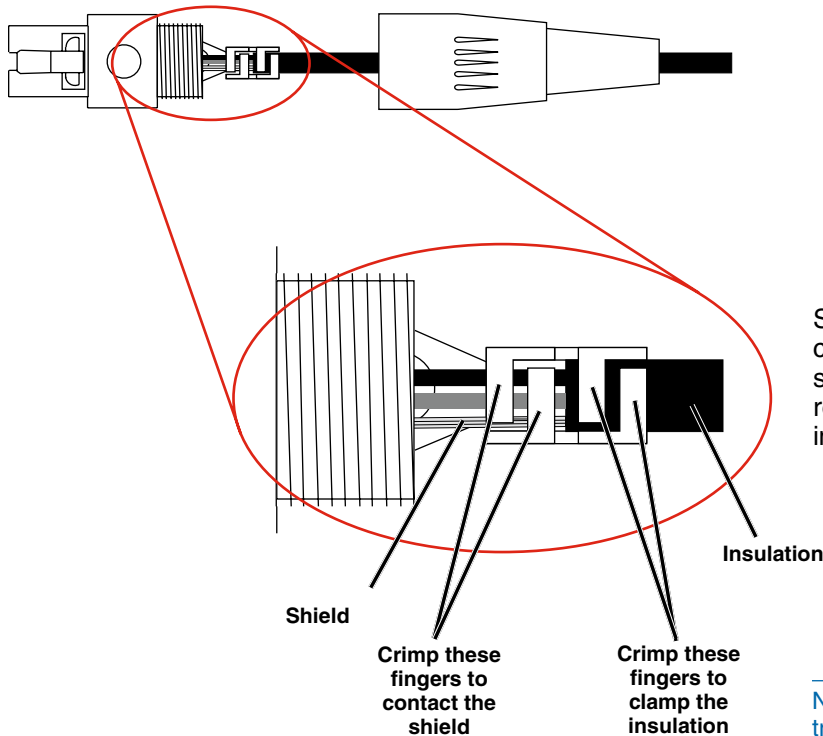

Strip and position the cable so that the clamp can be crimped to contact both the mic cable shield and the insulation. The shield contact reduces noise with some microphones and the insulation clamp increases ruggedness.

NOTE: This termination is intended for UHF transmitters only. VHF transmitters with 5-pin jacks require a different termination. Lectrosonics lavalier microphones are terminated for compatibility with VHF and UHF transmitters, which is different than what is shown here.

Wiring Hookups for Different Sources

In addition to the microphone and line level wiring hookups illustrated below, Lectrosonics makes a number of cables and adapters for other situations such as connecting musical instruments (guitars, bass guitars, etc.) to the transmitter. Visit www.lectrosonics.com and click on Accessories, or download the master catalog.

A lot of information regarding microphone wiring is also available in the FAQ section of the web site at:

<http://www.lectrosonics.com/faq.htm>

Follow the instructions to search by model number or other search options.

Compatible Wiring for Both Servo Bias Inputs and Earlier Transmitters:

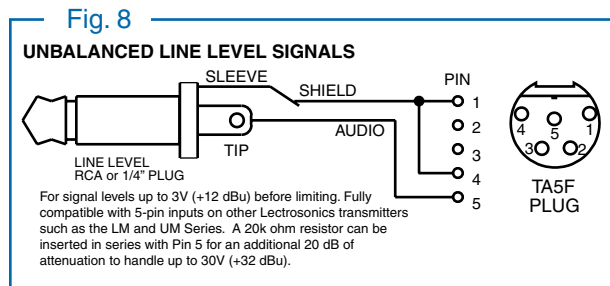
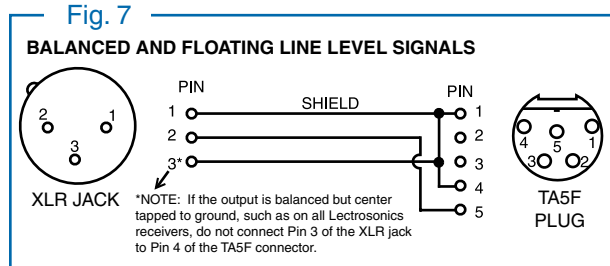
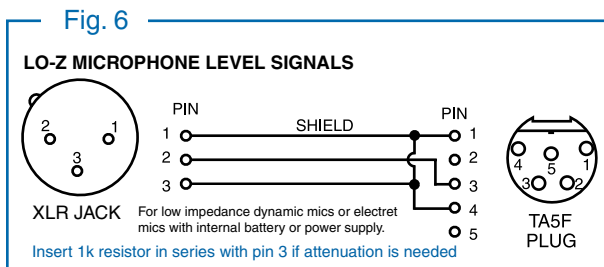
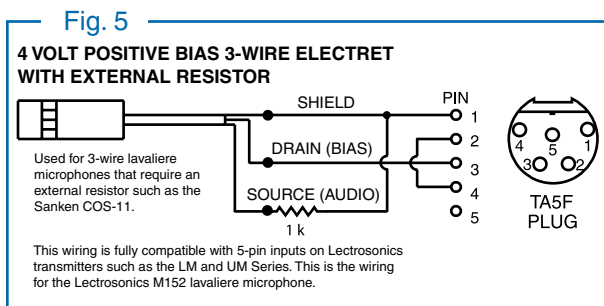
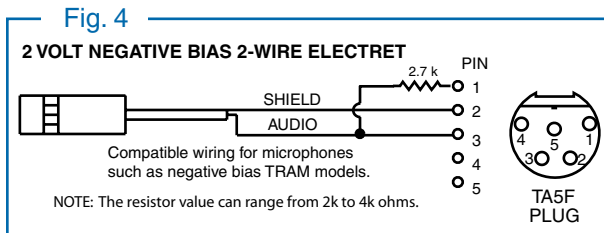
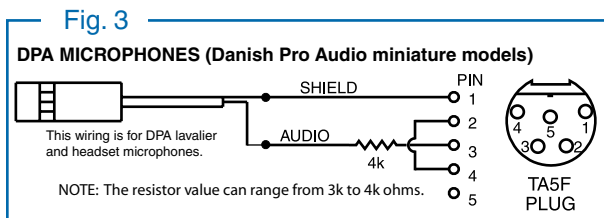
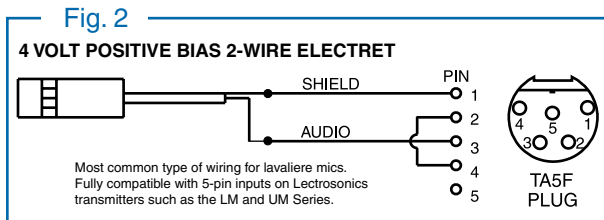
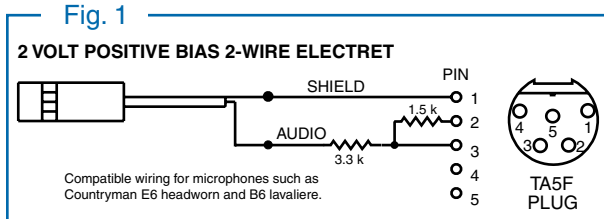

Simple Wiring - Can ONLY be used with Servo Bias Inputs:

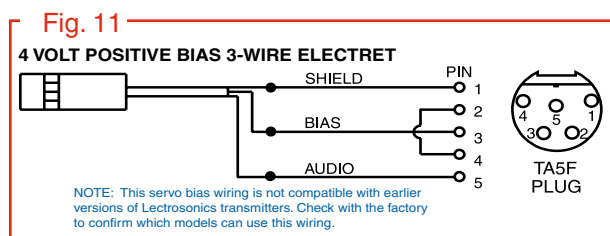
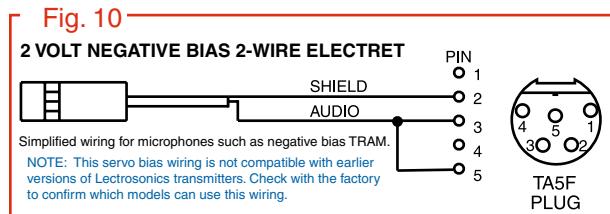
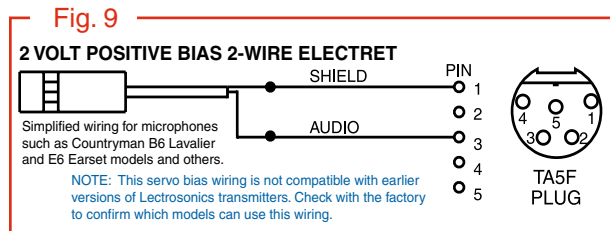

Silver Paste on SM Series Transmitter Thumbscrews

Silver paste is applied to thumbscrew threads on new units at the factory to improve the electrical connection from the battery compartment through the housing on any SM Series transmitter. This applies to the standard battery door and the battery eliminator.



The small enclosed vial contains a tiny amount (25 mg) of silver conductive paste. A small speck of this paste will improve the conductivity between the battery cover plate thumbscrew and the case of the SM.



The tiny vial is about 1/2 inch tall and contains 25 mg of silver paste.

With improved conductivity (lower resistance) more of the battery voltage can get to the internal power supplies causing reduced current drain and longer battery life. Though the amount seems very small, it is enough for years of use. It is, in fact, 25 times the amount that we use on the thumbscrews at the factory.

To apply the silver paste, first completely remove the cover plate from the SM housing by backing the thumbscrew completely out of the case. Use a **clean, soft cloth** to clean the threads of the thumbscrew.

NOTE: Do NOT use alcohol or a liquid cleaner.

Simply hold the cloth around the threads and turn the thumbscrew. Move to a new spot on the cloth and do it again. Do this until the cloth remains clean. Now, clean the threads in the case by using a dry cotton swab (Q-tip) or equivalent. Again, clean the case threads until a fresh cotton swab comes away clean.

Open the vial, and transfer a pinhead speck of silver paste to the second thread from the end of the thumbscrew. A easy way to pickup a speck of paste is to partially unfold a paper clip and use the end of the wire to acquire a tiny bit of paste. A toothpick will also work. An amount that covers the end of the wire is sufficient.

Apply paste to second thread from end of thumbscrew

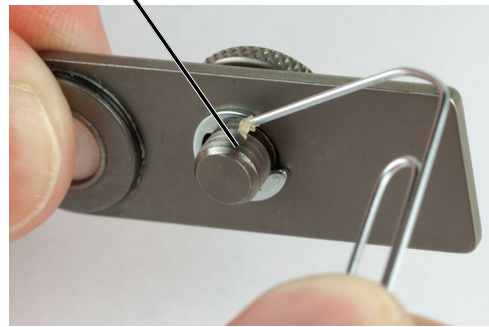

It is not necessary to spread the paste more than a little bit on the thread as the paste will spread itself every time the thumbscrew is screwed in and out of the case during battery changes.

Do not apply the paste to any other surfaces. The cover plate itself can be cleaned with a clean cloth by rubbing the slightly raised rings on the plate where it contacts the battery terminal. All you want to do is to remove any oils or dirt on the rings. Do not abrade these surfaces with a harsh material such as a pencil eraser, emery paper, etc., as this will remove the conductive nickel plating and expose the underlying aluminum, which is a poor contact conductor.

RM Remote Control

The RM unit gives you remote control of select Lectrosonics transmitters using an audible tone delivered to the microphone. Simply set the desired value or mode on the LCD, then press the send button to set the transmitter to the same setting or mode.



Only the specific function displayed is altered. For example, if the remote control is on the Aud (audio level/gain) screen, pressing the send button will set the gain on the transmitter but will not affect any other setting.



When the transmitter is in the power saving sleep mode, it uses only 20% of the normal battery drain, so battery life will be 5 times longer. This is especially useful in situations where the transmitter is buried deep inside clothing and there are waiting periods between use. The transmitter can “sleep” for several hours and then be awakened and adjusted when the production is about to begin. While the transmitter is asleep, the power LED will blink green every few seconds.

Powering the RM on and off

To turn the RM on or off, press the AUDIO and FREQ buttons together briefly. The unit powers up on the page that was displayed when the unit was last powered off.

RM Functions and Operation

To turn the power off and on, press the AUDIO and FREQ buttons at the same time. To enter the setup screen for the desired function, press the Access Button multiple times until the desired screen appears. Then use the arrow buttons to set the value or select the screen function.

Function	Access Button	Screen
Tx Input Gain	AUDIO	Aud
Sleep/Unsleep	AUDIO	SLEEP/unSLP
Lock/Unlock	AUDIO	Loc/unLoc
Tone loudness	AUDIO	Loud
Tx power output	AUDIO	Pr
Frequency	FREQ	b/CH/MHz

The frequency setup screens are as follows:

- b** Sets the frequency block
- CH** Sets the frequency by hex code
- MHz** Sets the frequency in Megahertz

Hold the speaker on the RM close to the microphone when pressing the send button. A “dweedle” tone will play from the RM speaker into the microphone and the parameter on the transmitter will be set immediately.

The speaker on the RM remote unit should be uncovered and held within a few inches of the transmitter’s microphone. The longest usable range is about 6 feet, but the distance varies depending on the microphone, transmitter gain and the tone loudness setting.



A single AA Lithium battery will operate the RM for up to several years. Unscrew the knurled knob for access to the battery compartment.

Operating Notes

- The sensitivity to the remote control varies with the transmitter's audio level setting and the microphone used, but it is always possible to make it work with a sufficiently loud remote signal at close range.
- If the transmitter is configured to respond to the remote control, it will do so even if the buttons are locked.
- When the transmitter is asleep, it can only be awakened by the remote control, or by removing and reinserting the battery.
- When the transmitter is asleep, the PWR led blinks green every few seconds.
- If a remote command is sent that would result in the same display being shown again on the transmitter (for example tuning to the channel already displayed), a row of dashes is displayed briefly, as a signal that the command was received, but it didn't change anything.
- If you are having trouble getting the transmitter to respond, make sure you aren't covering the speaker with your thumb, and/or turn up the speaker volume on the *Loud* page.
- If the RM is set to a different block number than the transmitter and an attempt is made to set the transmitter's frequency in MHz, the command will still work. The transmitter is simply set to the corresponding channel in the correct block, with a matching hexadecimal number.
- The audio signal from the RM will change the settings of all transmitters within range. Experiment with this to prevent accidental changes to another transmitter during a production.



The RM should be held close enough to the microphone to change the settings on the intended transmitter, and not be loud enough to affect other transmitters nearby.

RM2 Remote Control



A lower cost alternative to the RM, this model provides remote control of:

- Sleep/Unsleep
- Lock/Unlock
- Audio Level (gain)

This model operates on a "button cell" battery with a recessed trim pot (screwdriver adjusted) for the speaker level control.

LectroRM

By New Endian LLC

LectroRM is a mobile application for iOS and Android operating systems. Its purpose is to remotely control Lectrosonics Transmitters, including:

- SM Series
- WM
- L Series

The app remotely changes settings on the transmitter through the use of encoded audio tones, which when received by the attached microphone, will alter the configured setting. The app was released by New Endian, LLC in September 2011. The app is available for download and sells for \$20 on the Apple App Store and Google Play Store.

LectroRM's remote control mechanism is the use of an audio sequence of tones (dweedles) that are interpreted by the transmitter as a configuration change. The settings available in LectroRM are:

- Audio Level
- Frequency
- Sleep Mode
- Lock Mode

User Interface

The user interface involves selecting the audio sequence related to the desired change. Each version has an interface for selecting the desired setting and the desired option for that setting. Each version also has a mechanism to prevent accidental activation of the tone.

iOS

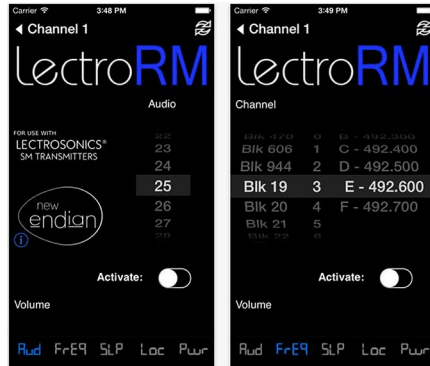

The iPhone version keeps each available setting on a separate page with the list of options for that setting. On iOS, the "Activate" toggle switch must be enabled to show the button which will then activate the audio. The iOS version's default orientation is upside-down but can be configured to orient right-side up. The purpose for this is to orient the device's speaker, which is at the bottom of the device, closer to the transmitter microphone.

Android

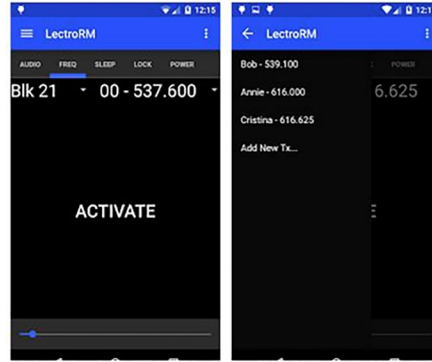

The Android version keeps all settings on the same page and allows the user to toggle between the activation buttons for each setting. The activation button must be long pressed to activate. The Android version also allows users to keep a configurable list of full sets of settings.

Activation

For a transmitter to respond to remote control audio tones, the transmitter must meet certain requirements:

- The transmitter must not be turned off; it can however be in sleep mode.
- The transmitter must have firmware version 1.5 or later for Audio, Frequency, Sleep and Lock changes.
- The transmitter microphone must be within range.
- The transmitter must be configured to enable remote control activation.

Please be aware this app is not a Lectrosonics product. It is privately owned and operated by New Endian LLC, www.newendian.com.

Straight Whip Antennas

This is a full size cutting template used to cut the length of the whip for a particular frequency. Lay the uncut antenna on top of this drawing and trim the whip length to the desired frequency.

After cutting the antenna to the desired length, mark the antenna by installing a color cap or sleeve to indicate the color listed in the table below

The supplied caps can be used several different ways:

- 1) A color cap on the end of the whip
- 2) A color sleeve next to the connector with a black cap on the end of the whip (trim the closed end of the colored cap off with scissors to make a sleeve).
- 3) A color sleeve and color cap (cut the cap in half with scissors).

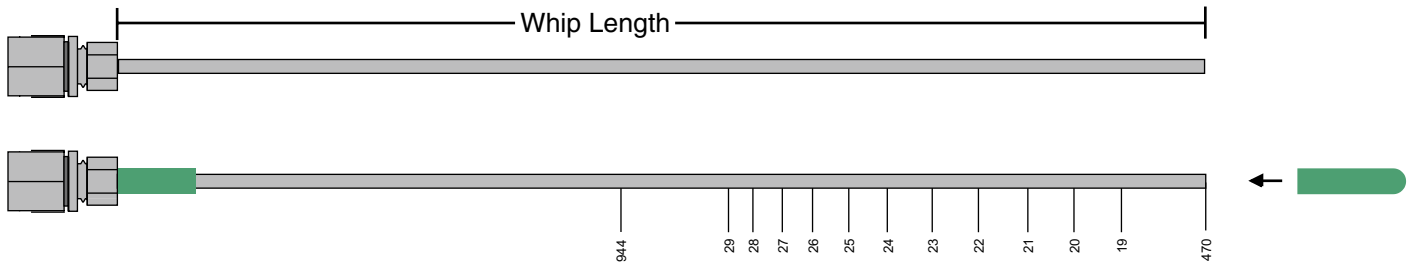

Note: Check the scale of your printout. This line should be 6.00 inches long (152.4 mm).

BLOCK	FREQUENCY RANGE	CAP/SLEEVE COLOR	ANTENNA WHIP LENGTH
470	470.100 - 495.600	Black w/ Label	5.67"
19	486.400 - 511.900	Black w/ Label	5.23"
20	512.000 - 537.500	Black w/ Label	4.98"
21	537.600 - 563.100	Brown w/ Label	4.74"
22	563.200 - 588.700	Red w/ Label	4.48"
23	588.800 - 614.300	Orange w/ Label	4.24"
24	614.400 - 639.900	Yellow w/ Label	4.01"
25	640.000 - 665.500	Green w/ Label	3.81"
26	665.600 - 691.100	Blue w/ Label	3.62"
944	944.100 - 951.900	Black-w/Label	2.62"

NOTE:

Not all Lectrosonics products are built on all of the blocks covered in this table.

Factory supplied antennas pre-cut to length include a label with the frequency range. Label is not supplied with this kit.

Accessories for single battery models:

PSM Leather pouch with integrated belt clip



SMBCUPSL Spring-loaded machined aluminum clip



SMBCDN Machined, wire belt clip for SMV transmitters, antenna down



SMBCUP Machined, wire belt clip for SMV transmitters, antenna up



Accessories for dual battery models:

PSMD Leather pouch with integrated belt clip



SMDBCSL Spring-loaded machined aluminum clip



SMDBC Machined, wire belt clip for SMQV transmitters



35924 Thermal insulated pad installed for SMQV



Place thermal insulation pad on back of unit, as pictured.

Accessories for Both Models

SMBATELIM External power adapter (battery eliminator) for all SM Series transmitters. 6 to 36 volt external sources. Handles up to 1 amp consumption. Protected against shorts and reverse polarity.

To install the battery eliminator, loosen the thumbscrew completely and remove the battery door. Insert the battery eliminator and tighten the thumbscrew.



SMKITTA5 Microphone connector kit with watertight sleeve for all SM Series transmitters.

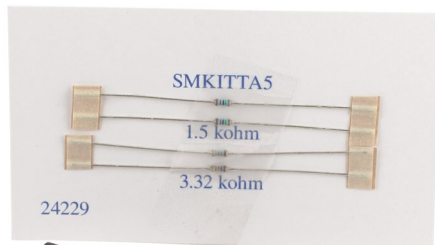

Troubleshooting

Before going through the following chart, be sure that you have a good battery in the transmitter. It is important that you follow these steps in the sequence listed.

SYMPTOM

POSSIBLE CAUSE

TRANSMITTER PWR LED OFF

- 1) Battery is inserted backwards or dead.
- 2) Transmitter not powered up. (See *Operating Instructions, Power UP and Boot Sequence.*)

TRANSMITTER PWR LED BLINKS GREEN EVERY FEW SECONDS, TRANSMITTER DOES NOT RESPOND OTHERWISE

- 1) Transmitter has been put to sleep by the remote control. Either use the remote control to wake it up again or remove and reinsert the transmitter's battery.

AUDIO LEVEL LEDs NOT LIGHTING

- 1) Gain control set to minimum.
- 2) Battery is dead or installed backwards. Check PWR LED.
- 3) Mic capsule is damaged or malfunctioning.
- 4) Mic cable damaged or mis-wired.

RECEIVER RF INDICATOR OFF

- 1) Transmitter not turned on, or is in Standby Mode.
- 2) Transmitter battery is dead.
- 3) Receiver antenna missing or improperly positioned.
- 4) Transmitter and receiver not on same frequency. Check switches/display on transmitter and receiver.
- 5) Transmitter and receiver not on same frequency block.
- 6) Operating range is too great.
- 7) Defective transmitter antenna.

NO SOUND (OR LOW SOUND LEVEL), RECEIVER INDICATES PROPER AUDIO MODULATION

- 1) Receiver output level set too low.
- 2) Receiver output disconnected, or cable defective or mis-wired.
- 3) Sound system or recorder input is turned down.

DISTORTED SOUND

- 1) Transmitter gain (audio level) is far too high. Check audio level LEDs and receiver audio levels during use.
- 2) Receiver output may be mismatched with the sound system or recorder input. Adjust output level on receiver to the correct level for the recorder, mixer or sound system. (Use the receiver's Tone function to check level.)
- 3) Transmitter is not set to same frequency as receiver. Check that operating frequency on receiver and transmitter match.
- 4) Receiver/Transmitter Compatibility Mode mismatched.

EXCESSIVE FEEDBACK

- 1) Transmitter gain (audio level) too high. Check gain adjustment and/or reduce receiver output level.
- 2) Talent standing too close to speaker system.
- 3) Mic is too far from user's mouth.

SYMPTOM**POSSIBLE CAUSE****HISS AND NOISE -- AUDIBLE DROPOUTS**

- 1) Transmitter gain (audio level) far too low.
- 2) Receiver antenna missing or obstructed.
- 3) Transmitter antenna broken or missing.
- 4) Operating range too great.
- 5) Signal interference. Turn off transmitter. If receiver's signal strength indicator does not drop to nearly zero, this indicates an interfering signal may be the problem. Try a different operating frequency.

“Loc” APPEARS IN DISPLAY WHEN ANY BUTTON IS PRESSED

- 1) Control Panel is locked. (See *Operating Instructions, Locking and Unlocking the Control Panel.*)

“Hold” APPEARS IN DISPLAY WHEN ARROW BUTTONS ARE PRESSED

- 1) Reminder that it is necessary to hold down the AUDIO or FREQ button to make adjustments to the audio gain or frequency settings.

“PLL” APPEARS IN DISPLAY

- 1) Indication that the PLL is not locked. This is a serious condition that requires factory repair. It may be possible to operate on another frequency far removed from the one that was selected when the condition was indicated.

TRANSMITTER WON'T RESPOND TO REMOTE CONTROL

- 1) If LCD blinks “rc OFF”, transmitter has not been configured to respond to the remote control. See “Remote Control Operation” on page 7 for instructions on how to configure.
- 2) If LCD blinks “- - - - -”, transmitter is already set as requested by the remote control.
- 3) If transmitter does not respond at all, try moving the remote control closer to the microphone or increasing the remote control's loudness setting, or increasing the audio level on the transmitter.
- 4) Make sure volume of RM and proximity of microphone are sufficient to engage transmitter.
- 5) Make sure transmitter is not in Sleep mode.

RM Troubleshooting**FREQUENCY CHANGES, BUT NOT TO DESIRED FREQUENCY**

- 1) RM set on different block than transmitter in question. RM uses hex code to set frequency - set RM to proper frequency block, or use hex code method to change frequency.

Specifications and Features

Operating frequencies:

Block 470	470.100 - 495.600	Block 24	614.400 - 639.900
Block 19	486.400 - 511.900	Block 25	640.000 - 665.500
Block 20	512.000 - 537.500	Block 26	665.600 - 691.100
Block 21	537.600 - 563.100		
Block 22	563.200 - 588.700		
Block 23	588.800 - 607.900		
	614.100 - 614.300		

(Frequency usage varies by country)

Frequency range:	256 frequencies in 100 kHz steps for one 25.5 MHz wide block
Channel Spacing:	100 kHz or 25 kHz
Frequency selection:	Control panel mounted membrane switches
RF Power output:	Switchable; 50, 100 or 250 mW
Compatibility Modes (6)	Digital Hybrid Wireless® (400 Series), 200 Series, 100 Series, Mode 3, Mode 6, IFB
Pilot tone:	25 to 32 kHz; 5 kHz deviation (in 400 Series Mode)
Frequency stability:	± 0.002%
Deviation:	± 75 kHz max. (in 400 Series Mode)
Spurious radiation:	60 dB below carrier
Equivalent input noise:	-125 dBV, A-weighted
Input level:	
If set for dynamic mic:	0.5 mV to 50 mV before limiting. Greater than 1 V with limiting.
If set for electret lavalier mic:	1.7 uA to 170 uA before limiting. Greater than 5000 uA (5 mA) with limiting.
Line level input:	17 mV to 1.7 V before limiting. Greater than 50 V with limiting.
Input impedance:	
Dynamic mic:	300 Ohms
Electret lavalier:	Input is virtual ground with servo adjusted constant current bias
Line level:	2.7 k Ohms
Input limiter:	DSP Controlled Soft limiter, 30 dB range
Bias voltages:	Fixed 5 V at up to 5 mA Selectable 2 V or 4 V servo bias for any electret lavalier.
Gain control range:	44 dB; panel mounted membrane switches
Modulation indicators:	Dual bicolor LEDs indicate modulation of -20, -10, 0, +10 dB referenced to full modulation.
Controls:	Control panel with LCD and four membrane switches.

Low frequency roll-off:

Adjustable from 35 to 150 Hz.

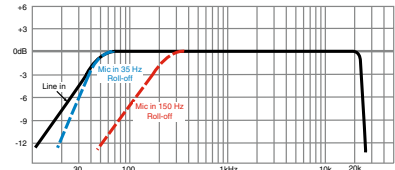

Audio Frequency Response:

35 Hz to 20 kHz, +/-1 dB (The low frequency roll-off is adjustable - see graph above)

Signal to Noise Ratio (dB): (overall system, 400 Series mode)	SmartNR	No Limiting	w/Limiting
	OFF	103.5	108.0
	NORMAL	107.0	111.5
	FULL	108.5	113.0

(Note: the dual envelope "soft" limiter provides exceptionally good handling of transients using variable attack and release time constants. The gradual onset of limiting in the design begins below full modulation, which reduces the measured figure for SNR without limiting by 4.5 dB)

Total Harmonic Distortion: 0.2% typical (400 Series mode)

Audio Input Jack: Switchcraft 5-pin locking (TA5F)

Antenna: Flexible, unbreakable steel cable.

Batteries: 1.5 Volt AA lithium

		Lithium
Battery Life:	SMV 50 mW (1 AA):	7.25 hrs
	SMV 100 mW (1 AA):	5.5 hrs
	SMV 250 mW (1 AA):	3 hrs
	SMQV 50 mW (2 AA):	14.5 hrs
	SMQV 100 mW (2 AA):	14 hrs
	SMQV 250 mW (2 AA):	7.5 hrs

Weight: RM: 2.3 oz.. (65.8 grams) with lithium battery
SMQV: 3.7 oz.. (105 grams) with lithium batteries

Overall Dimensions:

RM:	2.3 x 1.8 x 0.64 inches (not including microphone/lanyard) 58 x 46 x 16 mm (not including microphone/lanyard)	SMV:	2.3 x 1.8 x 0.64 inches (not including microphone/lanyard) 58 x 46 x 16 mm (not including microphone/lanyard)
RM2:	2.125 x 1.25 x 1.125 inches (not including microphone/lanyard) 54 x 32 x 29 mm (not including microphone/lanyard)	SMQV:	2.3 x 2.4 x 0.64 inches (not including microphone) 58 x 60 x 16 mm (not including microphone)

Emission Designator: 180KF3E

Specifications subject to change without notice.

The FCC requires that the following statements be included in this manual for the SMV and SMQV:

For body worn operation, this transmitter models has been tested and meets the FCC RF exposure guidelines when used with the Lectrosonics accessories supplied or designated for this product. Use of other accessories may not ensure compliance with FCC RF exposure guidelines. Contact Lectrosonics if you have any questions or need more information about RF exposure using this product..

This device complies with FCC radiation exposure limits as set forth for an uncontrolled environment. This device should be installed and operated so that its antenna(s) are not co-located or operating in conjunction with any other antenna or transmitter.

The FCC requires that the following statement be included in this manual for the RM:

This device complies with Part 15 of the FCC Rules. Operation is subject to the following two conditions: (1) This device may not cause harmful interference, and (2) this device must accept any interference received, including interference that may cause undesired operation.

This device complies with Industry Canada radiation exposure limits as set forth for a controlled "professional" use only.

Service and Repair

If your system malfunctions, you should attempt to correct or isolate the trouble before concluding that the equipment needs repair. Make sure you have followed the setup procedure and operating instructions. Check the interconnecting cables and then go through the **Troubleshooting** section in this manual.

We strongly recommend that you **do not** try to repair the equipment yourself and **do not** have the local repair shop attempt anything other than the simplest repair. If the repair is more complicated than a broken wire or loose connection, send the unit to the factory for repair and service. Don't attempt to adjust any controls inside the units. Once set at the factory, the various controls and trimmers do not drift with age or vibration and never require readjustment. **There are no adjustments inside that will make a malfunctioning unit start working.**

LECTROSONICS' Service Department is equipped and staffed to quickly repair your equipment. In warranty repairs are made at no charge in accordance with the terms of the warranty. Out-of-warranty repairs are charged at a modest flat rate plus parts and shipping. Since it takes almost as much time and effort to determine what is wrong as it does to make the repair, there is a charge for an exact quotation. We will be happy to quote approximate charges by phone for out-of-warranty repairs.

Returning Units for Repair

For timely service, please follow the steps below:

- A.** DO NOT return equipment to the factory for repair without first contacting us by email or by phone. We need to know the nature of the problem, the model number and the serial number of the equipment. We also need a phone number where you can be reached 8 A.M. to 4 P.M. (U.S. Mountain Standard Time).
- B.** After receiving your request, we will issue you a return authorization number (R.A.). This number will help speed your repair through our receiving and repair departments. The return authorization number must be clearly shown on the **outside** of the shipping container.
- C.** Pack the equipment carefully and ship to us, shipping costs prepaid. If necessary, we can provide you with the proper packing materials. UPS is usually the best way to ship the units. Heavy units should be "double-boxed" for safe transport.
- D.** We also strongly recommend that you insure the equipment, since we cannot be responsible for loss of or damage to equipment that you ship. Of course, we insure the equipment when we ship it back to you.

Lectrosonics USA:

Mailing address:

Lectrosonics, Inc.
PO Box 15900
Rio Rancho, NM 87174
USA

Shipping address:

Lectrosonics, Inc.
581 Laser Rd.
Rio Rancho, NM 87124
USA

Telephone:

(505) 892-4501
(800) 821-1121 Toll-free
(505) 892-6243 Fax

Web:

www.lectrosonics.com

E-mail:

sales@lectrosonics.com

Lectrosonics Canada:

Mailing Address:

720 Spadina Avenue,
Suite 600
Toronto, Ontario M5S 2T9

Telephone:

(416) 596-2202
(877) 753-2876 Toll-free
(877-7LECTRO)
(416) 596-6648 Fax

E-mail:

Sales: colinb@lectrosonics.com
Service: joeb@lectrosonics.com

LIMITED ONE YEAR WARRANTY

The equipment is warranted for one year from date of purchase against defects in materials or workmanship provided it was purchased from an authorized dealer. This warranty does not cover equipment which has been abused or damaged by careless handling or shipping. This warranty does not apply to used or demonstrator equipment.

Should any defect develop, Lectrosonics, Inc. will, at our option, repair or replace any defective parts without charge for either parts or labor. If Lectrosonics, Inc. cannot correct the defect in your equipment, it will be replaced at no charge with a similar new item. Lectrosonics, Inc. will pay for the cost of returning your equipment to you.

This warranty applies only to items returned to Lectrosonics, Inc. or an authorized dealer, shipping costs prepaid, within one year from the date of purchase.

This Limited Warranty is governed by the laws of the State of New Mexico. It states the entire liability of Lectrosonics Inc. and the entire remedy of the purchaser for any breach of warranty as outlined above. NEITHER LECTROSONICS, INC. NOR ANYONE INVOLVED IN THE PRODUCTION OR DELIVERY OF THE EQUIPMENT SHALL BE LIABLE FOR ANY INDIRECT, SPECIAL, PUNITIVE, CONSEQUENTIAL, OR INCIDENTAL DAMAGES ARISING OUT OF THE USE OR INABILITY TO USE THIS EQUIPMENT EVEN IF LECTROSONICS, INC. HAS BEEN ADVISED OF THE POSSIBILITY OF SUCH DAMAGES. IN NO EVENT SHALL THE LIABILITY OF LECTROSONICS, INC. EXCEED THE PURCHASE PRICE OF ANY DEFECTIVE EQUIPMENT.

This warranty gives you specific legal rights. You may have additional legal rights which vary from state to state.

