



Synthesized UHF Belt-Pack Transmitter

Featuring
Digital Hybrid Wireless®
Technology

US Patent 7,225,135



Quick Start Steps

- 1) Install good batteries and turn power on (see pages 6 - 8).
- 2) Set the compatibility mode to match the receiver (see page 11).
- 3) Connect the signal source and adjust input gain for optimum modulation level (see pages 11 and 12).
- 4) Set **Step Size** and frequency to match receiver (see page 12). Also see receiver manual for scanning procedure to find a clear operating frequency.
- 5) Turn on the receiver and verify that solid RF and audio signals are present (see receiver manual).



Fill in for your records:

Serial Number:

Purchase Date:



Rio Rancho, NM, USA
www.lectrosonics.com

Table of Contents

Introduction	4
Battery Installation	6
Belt Clips	6
IR (infrared) Sync	6
Operating Instructions	7
Battery Status LED Indicator	7
Powering On in Operating Mode.....	7
Powering On in Standby Mode	8
Powering Off	8
Entering the Main Menu.....	8
Entering the Power Menu.....	8
RF ON/OFF on the Main and Power Menus	8
LCD Menu Map	9
Power Menu Options	9
Main Menu and Setup Screen Details	10
Locking/Unlocking Changes to Settings.....	10
Selecting Programmable Switch Functions.....	10
Main Window Indicators	10
Selecting the Compatibility (Compat) Mode.....	11
Connecting the Signal Source	11
Using Line Level and Instrument Inputs	11
Selecting the Low Frequency Roll-off	11
Adjusting the Input Gain.....	12
Selecting Step Size.....	12
Selecting Frequency	12
Selecting Frequency Using Two Buttons.....	13
Helpful Features on Receivers.....	13
About Overlapping Frequency Bands	13
Selecting Audio Polarity (Phase).....	13
Selecting Battery Type	13
Enabling Remote Control.....	14
Setting Transmitter Output Power	14
Restoring Default Settings	14
IR Sync Operation.....	14
Accessories	15
5-Pin Input Jack Wiring	16
Microphone Cable Termination	
for Non-Lectrosonics Microphones	17
Input Jack Wiring for Different Sources	18
Compatible Wiring for Both Servo Bias Inputs	
and Earlier Transmitters:	18
Simple Wiring for Servo Bias Inputs ONLY:.....	18
Microphone RF Bypassing.....	19
Line Level Signals	19
Firmware Update	22
Troubleshooting	24
Specifications and Features	25
Service and Repair	26
Returning Units for Repair	26

Consumer Alert for US Users - FCC Order DA 10-92

Most users do not need a license to operate this wireless microphone system. Nevertheless, operating this microphone system without a license is subject to certain restrictions: the system may not cause harmful interference; it must operate at a low power level (not in excess of 50 milliwatts); and it has no protection from interference received from any other device. Purchasers should also be aware that the FCC is currently evaluating use of wireless microphone systems, and these rules are subject to change. For more information, call the FCC at 1-888- CALL-FCC (TTY: 1-888-TELL-FCC) or visit the FCC's wireless microphone website at www.fcc.gov/cgb/wirelessmicrophones. To operate wireless microphone systems at power greater than 50mW, you must qualify as a Part 74 user and be licensed. If you qualify and wish to apply for a license go to: <http://www.fcc.gov/Forms/Form601/601.html>

Introduction

The design of the LT transmitter delivers the advanced technology and features of Digital Hybrid Wireless® in a Lectrosonics belt-pack transmitter at a modest cost. Digital Hybrid Wireless® combines a 24-bit digital audio chain with an analog FM radio link to eliminate a compandor and its artifacts, yet preserve the extended operating range and noise rejection of the finest analog wireless systems. DSP “compatibility modes” allow the LT to also be used with a variety of analog receivers by emulating the compandors found in earlier Lectrosonics analog wireless and IFB receivers, and certain receivers from other manufacturers (contact the factory for details).

The housing is a rugged, machined aluminum package with removable, stainless steel wire belt clip. The input jack is a standard Lectrosonics 5-pin type for use with electret lavalier mics, dynamic mics, musical instrument pickups and line level signals. The LEDs on the top panel allow quick and accurate level settings without having to view the receiver. The unit is powered by two AA batteries. The antenna port uses a standard 50 ohm SMA connector. Straight and hinged whip antennas are available.

The switching power supplies in the LT provide constant voltages to the transmitter circuits from the beginning to the end of battery life, with output power remaining constant over the life of the battery. The input amplifier uses an ultra low noise op amp. Input gain is adjustable over a 44 dB range, with a DSP-controlled dual envelope input limiter that will cleanly handle signal peaks over 30 dB above full modulation.

About Digital Hybrid Wireless®

All wireless links suffer from channel noise to some degree, and all wireless microphone systems seek to minimize the impact of that noise on the desired signal. Conventional analog systems use compandors for enhanced dynamic range, at the cost of subtle artifacts (known as “pumping” and “breathing”). Wholly digital systems defeat the noise by sending the audio information in digital form, at the cost of some combination of power, bandwidth, operating range and resistance to interference.

The Lectrosonics Digital Hybrid Wireless system overcomes channel noise in a dramatically new way, digitally encoding the audio in the transmitter and decoding it in the receiver, yet still sending the encoded information via an analog FM wireless link. This proprietary algorithm is not a digital implementation of an analog compandor but a technique which can be accomplished only in the digital domain.

Since the RF link between transmitter and receiver is FM, channel noise will increase gradually with increased operating range and weak signal conditions, however, the Digital Hybrid Wireless system handles this situation elegantly with rarely audible audio artifacts as the receiver approaches its squelch threshold.

In contrast, a purely digital system tends to drop the audio suddenly during brief dropouts and weak signal conditions. The Digital Hybrid Wireless system simply encodes the signal to use a noisy channel as efficiently and robustly as possible, yielding audio performance that rivals that of purely digital systems, without the power, noise and bandwidth problems inherent in digital transmission. Because it uses an analog FM link, Digital Hybrid Wireless enjoys all the benefits of conventional FM wireless systems, such as excellent range, efficient use of RF spectrum, and long battery life.

Frequency Agility

Frequency selection is provided in 100 kHz or 25 kHz steps with up to 3072 channels available covering three standard Lectrosonics 25.6 MHz bands. Frequencies are displayed on the LCD in MHz and in a hex code used with earlier Lectrosonics equipment.

Wide-Band Deviation

Deviation has a direct effect on the dynamic range and signal to noise ratio of an FM system. The greater the deviation, the wider the dynamic range and the better the signal to noise ratio. In the Digital Hybrid Wireless mode, the system operates with a maximum of +/-75 kHz of deviation. The resulting 180 kHz of occupied bandwidth just fits inside the government specified spectral mask of 200 kHz. In order to make this possible, an advanced, DSP-controlled limiter is used to prevent signal peaks from exceeding the maximum allowed bandwidth, but not cause distortion.

The result of all this is that the audio quality is outstanding, rivaling a hard-wired microphone. The system delivers a very wide dynamic range, and can handle loud signal peaks without distortion.

Servo Bias Input and Wiring

The LT input preamp is a unique design that delivers audible improvements over conventional transmitter inputs. The transmitters are easier to use and much harder to overload. It is not necessary to introduce pads on some mics to prevent overload of the input stage, divide the bias voltage down for some low voltage mics, or reduce the limiter range at minimum gain settings.

Two different microphone wiring schemes are available to simplify and standardize the configuration. Simplified 2-wire and 3-wire configurations provide several arrangements designed for use only with servo bias inputs to take full advantage of the preamp circuitry. Other wiring schemes are compatible with Servo Bias and conventional inputs.

A line level input wiring provides an extended frequency response with an LF roll-off at 35 Hz for use with instruments and line level signal sources.

DSP-controlled Input Limiter

The transmitter employs a digitally-controlled analog audio limiter prior to the analog-to-digital converter. The limiter has a range greater than 30 dB for excellent overload protection. A dual release envelope makes the limiter acoustically transparent while maintaining low distortion. It can be thought of as two limiters in series, connected as a fast attack and release limiter followed by a slow attack and release limiter. The limiter recovers quickly from brief transients, so that its action is hidden from the listener, but recovers slowly from sustained high levels to keep audio distortion low and preserve short term dynamic changes in the audio.

No Pre-Emphasis/De-Emphasis

Because the signal to noise ratio of the Digital Hybrid Wireless system is so high, there is no need for conventional pre-emphasis (HF boost) in the transmitter and de-emphasis (HF roll off) in the receiver. Thus, the potential distortion problems associated with pre-emphasis and de-emphasis are eliminated.

Pilot Tone Squelch

The **squelch** system in a receiver is a method of muting the audio when the RF signal conditions are too poor to produce usable audio. While not all squelch systems work the same way, the goal is always the same: to discard noise and unusable audio.

The Digital Hybrid Wireless system employs a DSP-generated supersonic tone (pilot tone), using it as a kind of signature, so the receiver can mute even strong signals that aren't from the appropriate transmitter. The pilot tone also helps to ensure that the receiver is quiet when the transmitter is turned on and off.

256 different pilot tones provide reliable operation in multi-channel wireless systems. A different tone is generated every 100 kHz across the tuning range of the system, so that a tone is not repeated until it is 25.6 MHz above or below the previous one.

LT Block Diagram

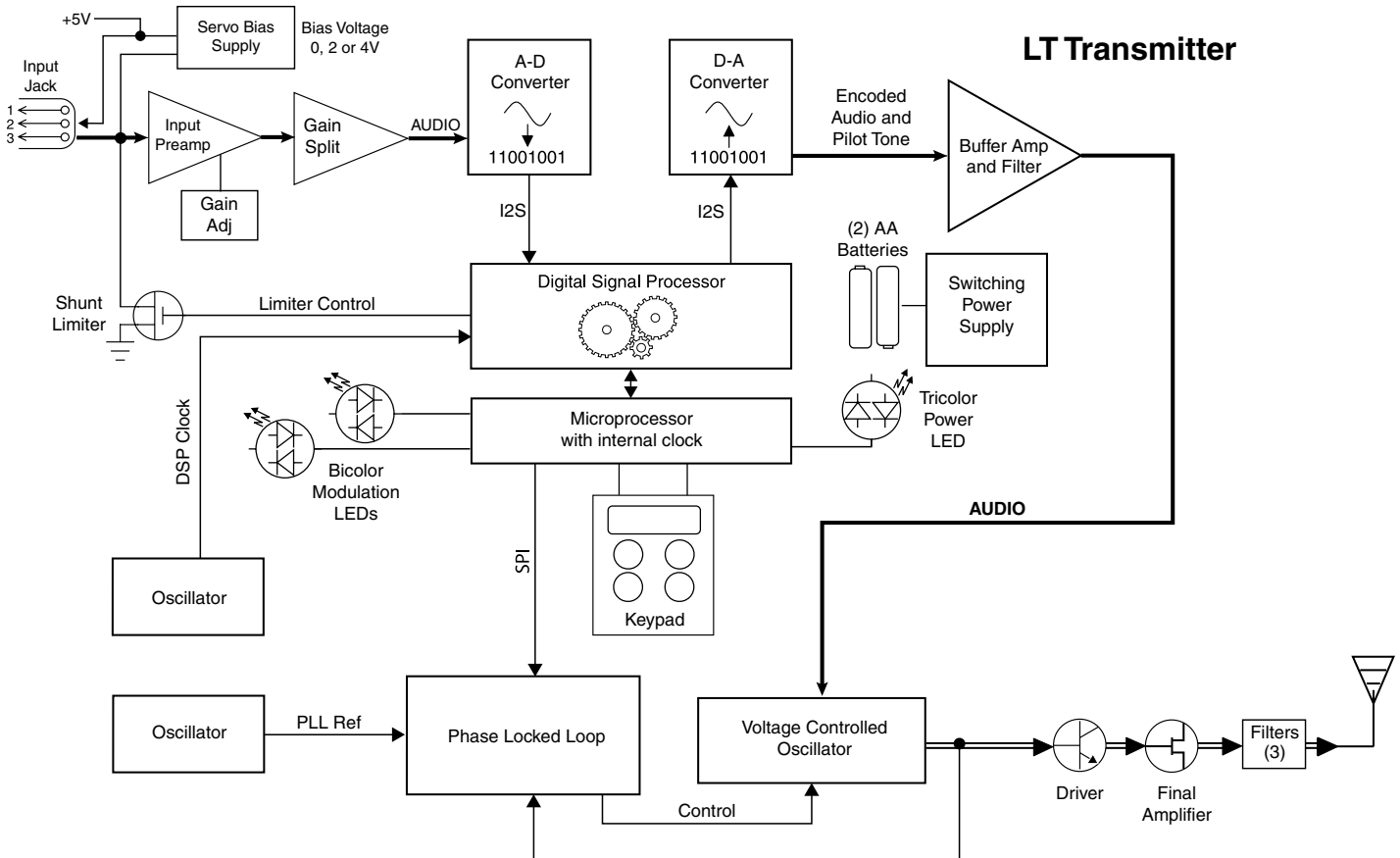

Battery Installation

The transmitter is powered by two AA batteries. We recommend using alkaline, lithium, or rechargeable batteries for longest life. Standard zinc-carbon batteries marked “heavy-duty” or “long-lasting” are not adequate.

The battery status circuitry compensates for the difference in voltage drop between alkaline and lithium batteries across their usable life, so it’s important to select the correct battery type in the menu.

Because rechargeable batteries run down quite abruptly, using the Power LED to verify battery status will not be reliable. However, it is possible to track battery status using the battery timer function available in Lectrosonics Digital Hybrid Wireless receivers.

Push outward on the battery compartment door and lift it to open.



Insert the batteries according to the markings on the back of the housing.



If the batteries are inserted incorrectly, the door will close but the unit will not operate.

The battery contacts can be cleaned with alcohol and a cotton swab, or a clean pencil eraser. Be sure not to leave any remnants of the cotton swab or eraser crumbs inside the compartment.

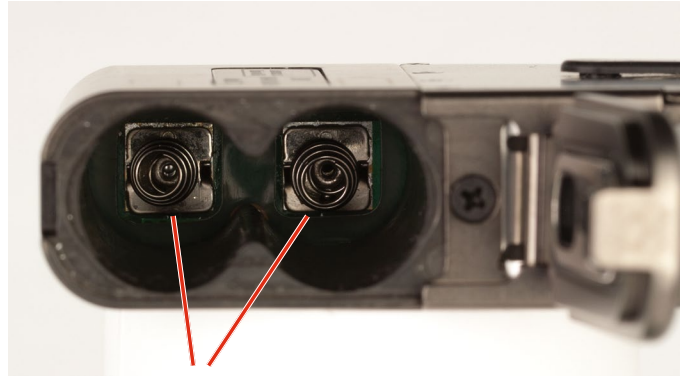

Contact springs

Belt Clips

The wire belt clip may be removed by pulling the ends out of the holes in the sides of the case. Use pliers to grasp the wire and avoid scratching the surface of the housing. Pliers also help when installing the clip.

An optional spring-loaded, hinged belt clip (model number BCSLEBN) is also available. This clip is attached by removing the plastic hole cap on the back of the housing and mounting the clip with the supplied screw.

IR (infrared) Sync

The opening on the keypad is an IR port for quick setup using a receiver with this function available. IR Sync will transfer the settings for frequency, step size and compatibility mode from the receiver to the transmitter. Refer to your page 13 of this manual and to the receiver manual for details.

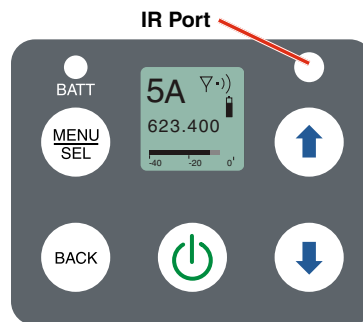

NOTE: If a mismatch exists between the receiver and transmitter, an error message will appear on the transmitter LCD stating what the problem is. See page 13 for more information.

Operating Instructions



Full access to all settings is provided through the keypad and LCD. The transmitter can also be configured as a “one button” device by locking the ability to make changes with the keypad, and configuring the top panel switch as either power on/off or a mute function.

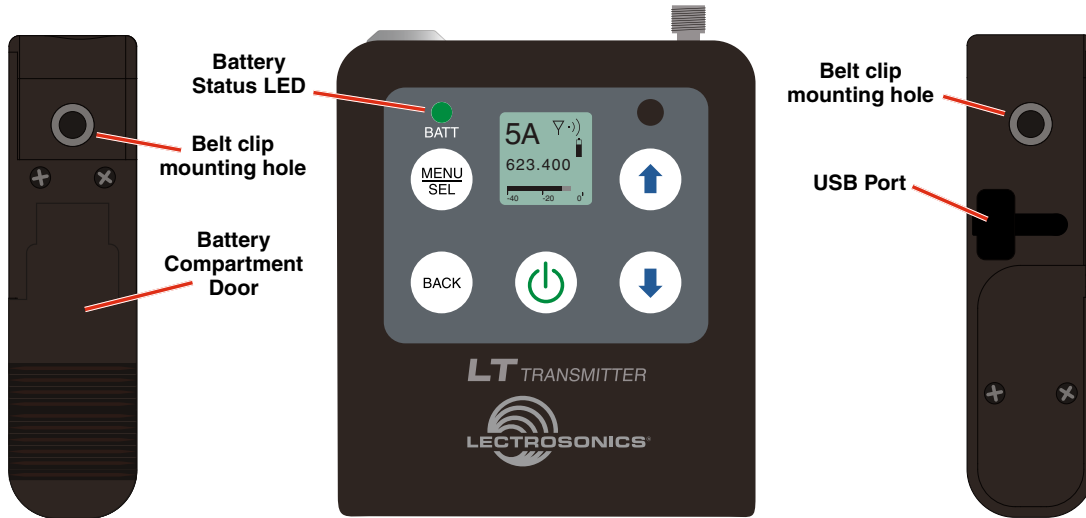

Battery Status LED Indicator

Alkaline, lithium or rechargeable batteries can be used to power the transmitter. The type of batteries in use are selectable in a menu on the LCD.

When alkaline or lithium batteries are being used, the LED labeled BATT on the keypad glows green when the batteries are good. The color changes to red when the battery voltage drops down and stays red through most of the battery life. When the LED begins to *blink* red, there will be only a few minutes remaining.

The exact point at which the LEDs turn red will vary with battery brand and condition, temperature and power consumption. The LEDs are intended to simply catch your attention, not to be an exact indicator of remaining time.

The Power/Function LED on the top panel will mirror the keypad LED unless the programmable switch is set to the Mute or Talkback mode, and the switch is turned on.

A weak battery will sometimes cause the LED to glow green immediately after the transmitter is turned on, but it will soon discharge to the point where the LED will turn red or the unit will turn off completely.

Rechargeable batteries give little or no warning when they are depleted. If you wish to use these batteries in the transmitter, you will need to manually keep track of the operating time to prevent interruptions caused by dead batteries.

Start with a fully charged battery, then measure the time it takes for the Power LED to go out completely.

NOTE: The battery timer feature in many Lectrosonics receivers is very helpful in measuring battery runtime when using rechargeable batteries. Refer to the receiver instructions for details on using the timer.

Powering On in Operating Mode

Press and hold the Power Button  for several seconds until a counter on the LCD progresses from 1 through 3, followed by a display of the model, firmware version, frequency band and compatibility mode.



When you release the button, the unit will be operational with the RF output turned on and the Main Window displayed. Only the second and third screens will appear when the programmable function switch is used to turn on the power.

Powering On in Standby Mode

A brief press of the Power Button , releasing it before the counter has reached 3, will turn the unit on with the RF output turned off. In this Standby Mode the menus can be browsed to make settings and adjustments without the risk of interfering with other wireless systems nearby.

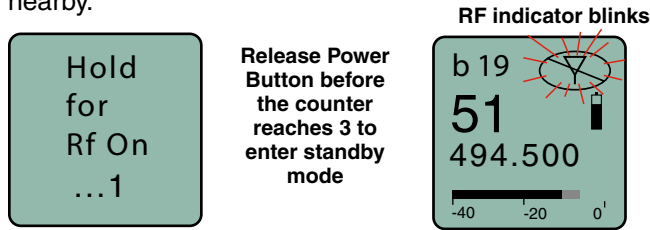

After settings and adjustments are made, press the power button again to turn the unit off.

NOTE: Also see the section entitled *Entering The Power Menu* for the AutoOn feature.

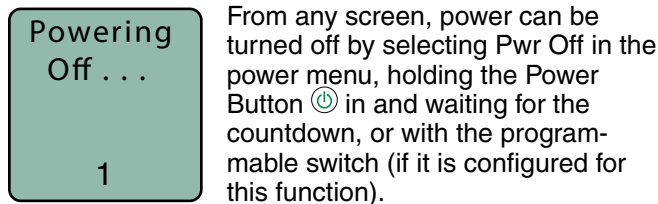

Powering Off



If the power button is released, or the top panel switch is turned back on again before the countdown is completed, the unit will remain turned on and the LCD will return to the same screen or menu that was displayed previously.

NOTE: If the programmable switch is in the OFF position, power can still be turned on with the power button. If the programmable switch is then turned on, a brief message will appear on the LCD.

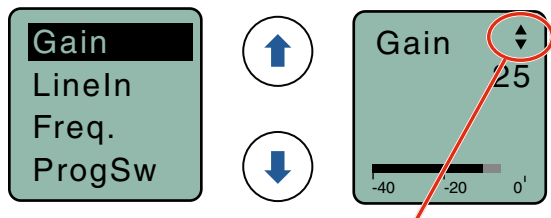

Entering the Main Menu

The LCD and keypad interface makes it easy to browse the menus and make the selections for the setup you need. When the unit is powered up in either the operating or the standby mode, press MENU/SEL on the keypad to enter a menu structure on the LCD. Use the  and  arrow buttons to select the menu item. Then press the MENU/SEL button to enter the setup screen.



The prompt in the upper right corner may display one or both arrows, depending upon what adjustment can be made. If the changes are locked, a small padlock symbol will appear.

Entering the Power Menu

Press the power button  from any menu or screen and a menu will appear with several options. Use the  and  arrow buttons to select the menu item. Then press MENU/SEL to execute the item or enter a setup screen. See opposite page for details.

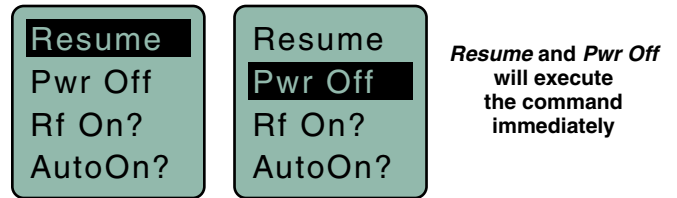

Resume and **Pwr Off** will execute the command immediately. The other menu items will open a screen asking for a value to be selected.

The screens that prompt for a selection to be made are straightforward as in this example. Use the UP and DOWN arrows to highlight the desired selection and press MENU/SEL or BACK to confirm it.

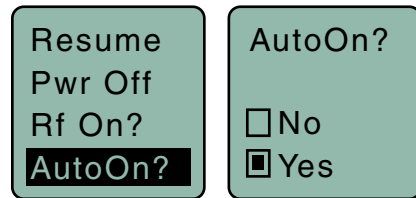

RF ON/OFF on the Main and Power Menus

The RF output of the transmitter can be turned off and on with a menu item on both the main menu and on the power menu.

Rf On? in the main menu:

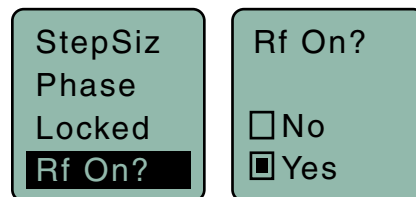

Rf On? in the power menu:

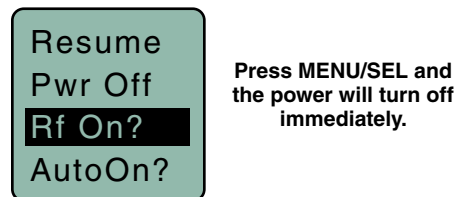

LCD Menu Map

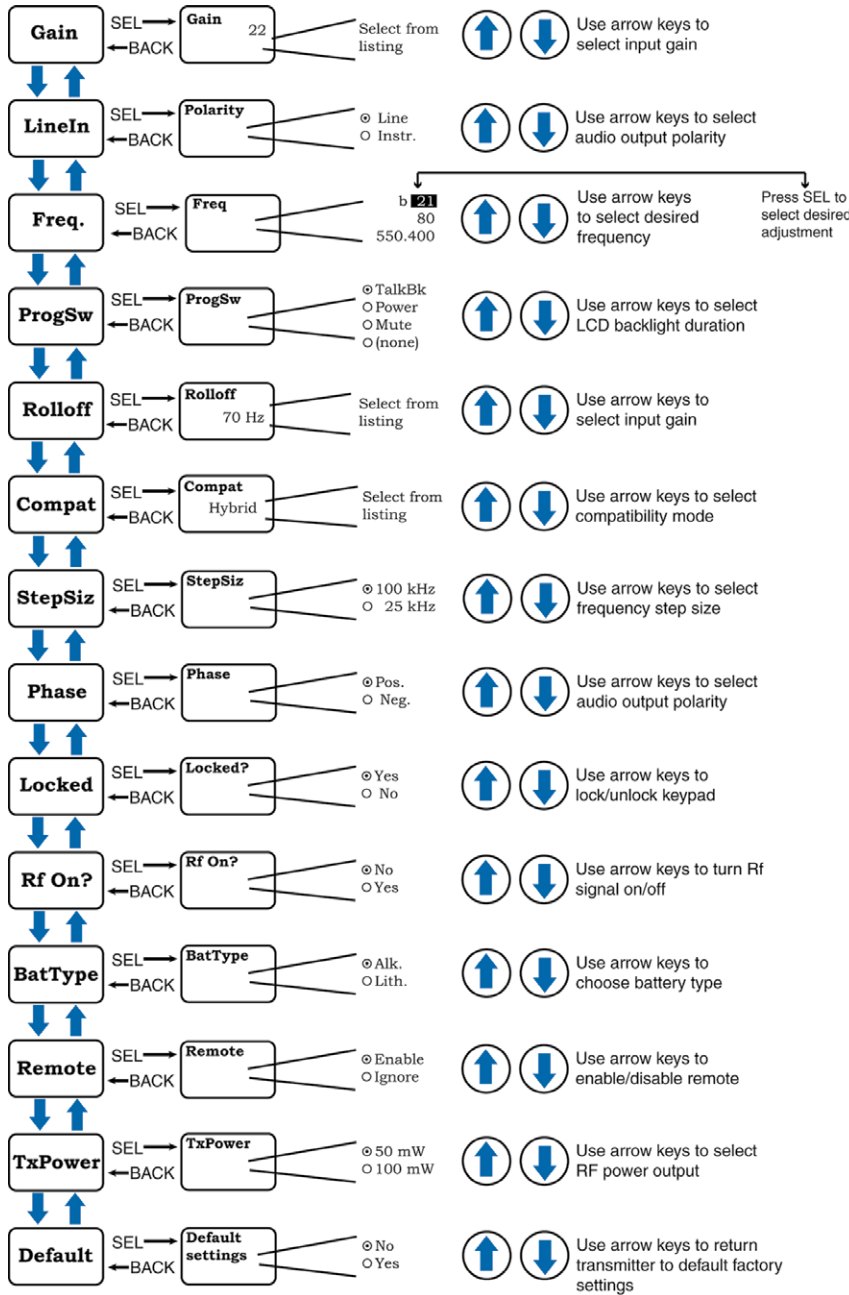

Power Menu Options

A special menu is provided by pressing the power button (⏻) from any screen or menu when the unit is turned on in either the Operating or Standby modes. The menu includes several options. Use the (⬆️) and (⬆️) arrow buttons to select the menu item.

- **Resume** - returns to the previous mode and screen
- **Pwr Off** - turns the unit off irrevocably
- **Rf On?** - enters a screen to enable the operating or standby modes

- **AutoOn?** - allows the unit to automatically turn back on after a power failure or when fresh batteries are installed (works in the operating mode only)
- **Backlit** - adjusts the duration of the LCD back light to 30 seconds or 5 minutes, or to remain on
- **LED Off** - turns the LEDs on (Normal) or off (Dark)
- **About** - displays the installed firmware version.

Main Menu and Setup Screen Details

Locking/Unlocking Changes to Settings

Changes to the settings can be locked.

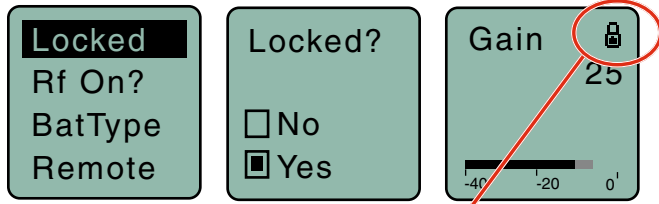

A small padlock symbol will appear on adjustment screens when changes have been locked.

When changes are locked, several controls and actions can still be used:

- Settings can still be unlocked
- Menus can still be browsed
- Programmable switch still works
- Power can still be turned off by using the power menu or removing the batteries.

Selecting Programmable Switch Functions

The programmable switch on the top panel can be configured using the menu to provide several functions:

- **Power** - turns the power on and off
- **Mute** - mutes the audio when switched on
- **TalkBk** (talkback) - redirects the audio to a different output channel on the receiver (with receivers that offer this function)
- **(none)** - disables the switch

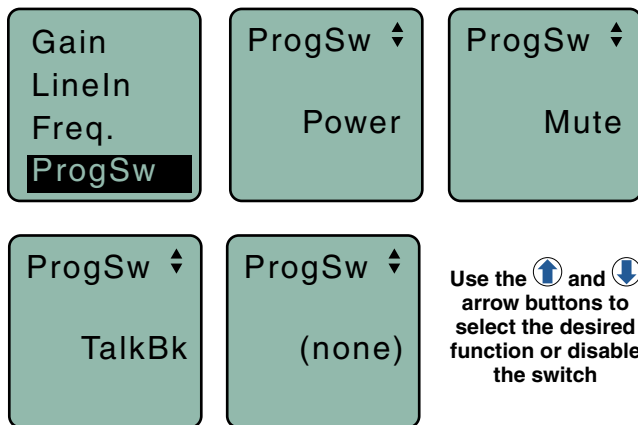

NOTE: The programmable switch will continue to operate whether or not keypad changes are locked.

Main Window Indicators

The Main Window displays the band number, Standby or Operating mode, operating frequency, audio level, battery status and programmable switch function. When the frequency step size is set at 100 kHz, the LCD will look like the following.

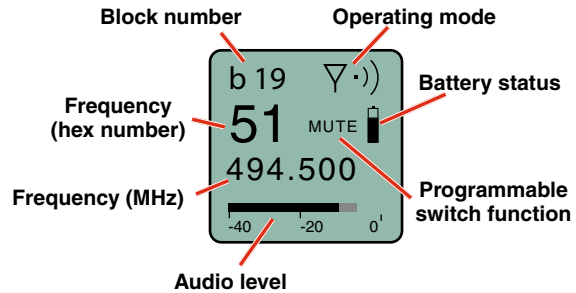

When the frequency step size is set to 25 kHz, the hex number will appear smaller and may include a fraction.

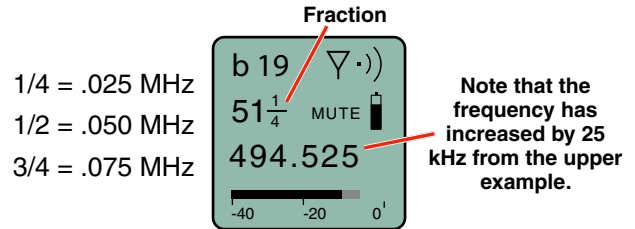

Changing the step size never changes the frequency. It only changes the way the user interface works. If the frequency is set to a fractional increment between even 100 kHz steps and the step size is changed to 100 kHz, the hex code will be replaced by two asterisks on the main screen and the frequency screen.

Frequency set to fractional 25 kHz step, but step size changed to 100 kHz.

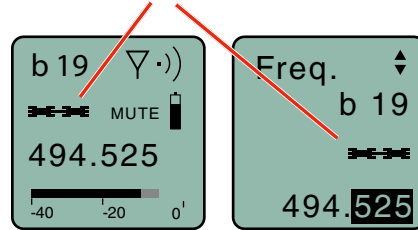

If the programmable switch function is set for Mute, the Main Window will indicate that the function is enabled.

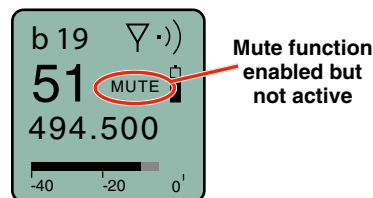

When the switch is turned on, the mute icon appearance will change, the word MUTE will blink at the bottom of the display, and the power/function LED will blink blue.

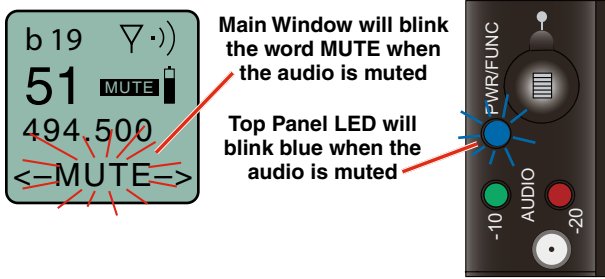

Main Window will blink the word MUTE when the audio is muted
 Top Panel LED will blink blue when the audio is muted

If the programmable switch function is set for Talkback, the Main Window will indicate that the function is enabled but not active.

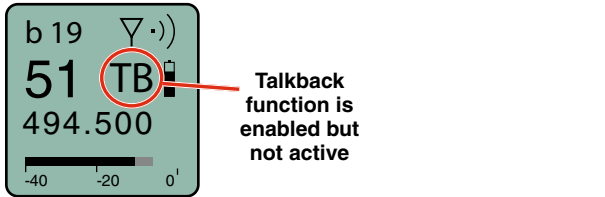

Talkback function is enabled but not active

When the programmable switch is turned on, the talkback icon appearance will change and the power/function LED will glow blue.

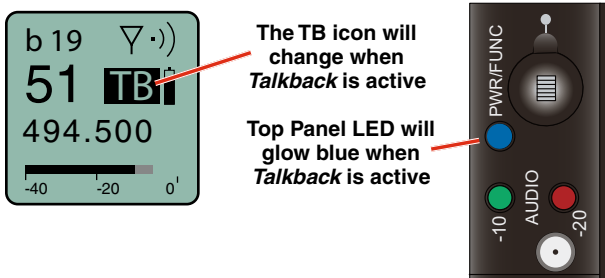

The TB icon will change when Talkback is active
 Top Panel LED will glow blue when Talkback is active

Selecting the Compatibility (Compat) Mode

When used with a Lectrosonics Digital Hybrid Wireless® receiver, the best audio quality will be achieved with the system set to the Hybrid compatibility mode.

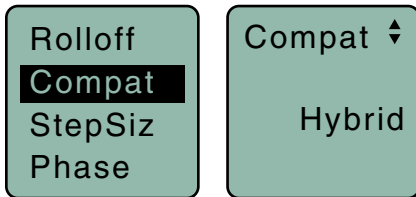

Use the UP and DOWN arrows to select the desired mode, then press the BACK button twice to return to the Main Window.

Compatibility modes are as follows:

Receiver Models	LCD menu item
• 100 Series:	100 Mode
• 200 Series:	200 Mode
• Mode 3:*	Mode 3
• Digital Hybrid Wireless®:	Hybrid
• IFB Series:	IFB Mode
• Mode 6:*	Mode 6
• Mode 7:*	Mode 7

100 Series works with Lectrosonics UCR100 analog receivers.

200 Series works with Lectrosonics earlier UCR201/205/210D/211 and UCR195 analog receivers with dual band companders.

Mode 3* works with certain non-Lectrosonics models.

Digital Hybrid Wireless® works with all Lectrosonics Digital Hybrid receivers. The receiver must also be set to the Digital Hybrid compatibility mode.

IFB Series works with Lectrosonics IFB R1/R1a analog receivers.

Mode 6* works with certain non-Lectrosonics models.

Mode 7* works with certain non-Lectrosonics models.

* Contact the factory for details of these modes

Connecting the Signal Source

Microphones, line level audio sources and instruments can be used with the transmitter. Refer to the section entitled **Wiring Hookups for Different Sources** for details on the correct wiring for line level sources and microphones to take full advantage of the Servo Bias circuitry.

Using Line Level and Instrument Inputs

Two types of high levels signals can be used with the transmitter:

- **Line** Used with line level outputs from recorders, mixers and other audio devices.
- **Instr.** (instrument) A special type of high impedance input with an active preamp for an optimal match with instrument pickups.

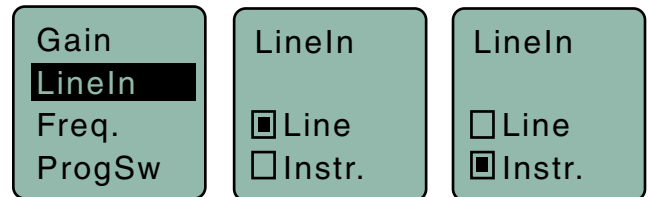

The wiring of the connector is the same for both types of inputs.

Selecting the Low Frequency Roll-off

Low frequency audio content may be desirable or distracting, so the point at which the roll-off takes place can be set to 35, 50, 70, 100, 120 and 150 Hz.

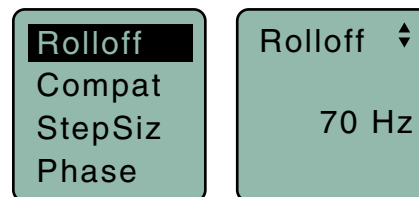

Adjusting the Input Gain

The two bicolor Modulation LEDs on the control panel provide a visual indication of the audio signal level entering the transmitter. The LEDs will glow either red or green to indicate modulation levels as shown in the following table.

Signal Level	-20 LED	-10 LED
Less than -20 dB	● Off	● Off
-20 dB to -10 dB	● Green	● Off
-10 dB to +0 dB	● Green	● Green
+0 dB to +10 dB	● Red	● Green
Greater than +10 dB	● Red	● Red

NOTE: Full modulation is achieved at 0 dB, when the “-20” LED first turns red. The limiter can cleanly handle peaks up to 30 dB above this point.

It is best to go through the following procedure with the transmitter in the standby mode so that no audio will enter the sound system or recorder during adjustment.

- 1) With fresh batteries in the transmitter, power the unit on in the standby mode (see previous section **Powering On in Standby Mode**).
- 2) Navigate to the Gain setup screen.

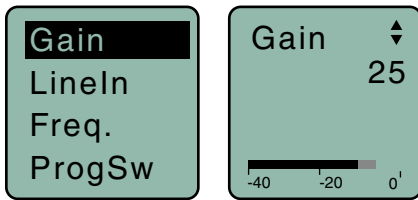

- 3) Prepare the signal source. Position a microphone the way it will be used in actual operation and have the user speak or sing at the loudest level that will occur during use, or set the output level of the instrument or audio device to the maximum level that will be used.
- 4) Use the \uparrow and \downarrow arrow buttons to adjust the gain until the **-10 dB** glows green and the **-20 dB** LED starts to flicker red during the loudest peaks in the audio.
- 5) Once the audio gain has been set, the signal can be sent through the sound system for overall level adjustments, monitor settings, etc.
- 6) If the audio output level of the receiver is too high or low, use only the controls on the receiver to make adjustments. Always leave the transmitter gain adjustment set according to these instructions, and do not change it to adjust the audio output level of the receiver.

Selecting Step Size

This menu item allows frequencies to be selected in either 100 kHz or 25 kHz increments.



If the desired frequency ends in .025, .050 or .075 MHz, the 25 kHz step size must be selected.

Normally, the receiver is used to find a clear operating frequency. All Lectrosonics Digital Hybrid Wireless® receivers provide a scanning function to quickly and easily find prospective frequencies with little or no RF interference. In other cases, a frequency may be specified by officials at a large event such as the Olympics or a major league ball game. Once the frequency is determined, set the transmitter to match the associated receiver.

Selecting Frequency

The setup screen for frequency selection offers several ways to browse the available frequencies.

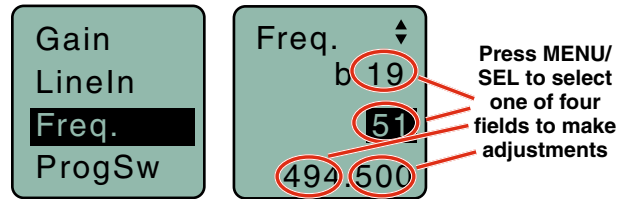

Each field will step through the available frequencies in a different increment. The increments are also different in the 25 kHz mode from the 100 kHz mode.

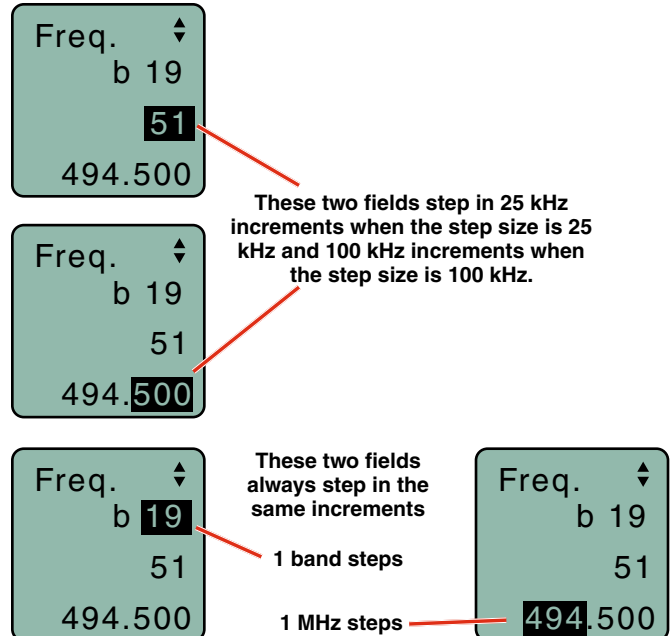

A fraction will appear next to the hex code in the setup screen and in the main window when the frequency ends in .025, .050 or .075 MHz.



Selecting Frequency Using Two Buttons

Hold the MENU/SEL button in, then use the \uparrow and \downarrow arrow buttons for alternate increments.

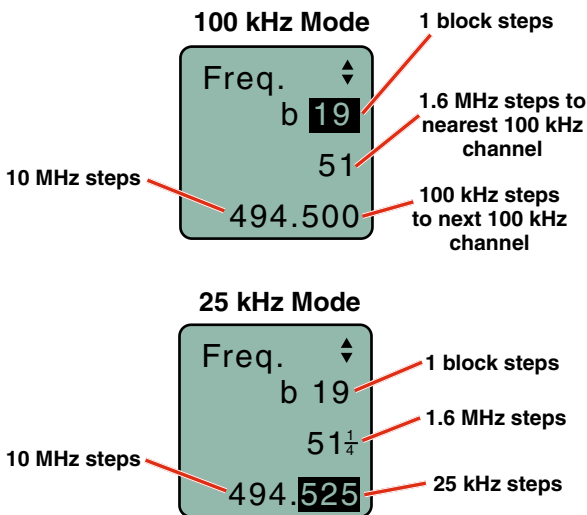

If the Step Size is 25 kHz with the frequency set between even 100 kHz steps and the Step Size is then changed to 100 kHz, the mismatch will cause the hex code to display as two asterisks.

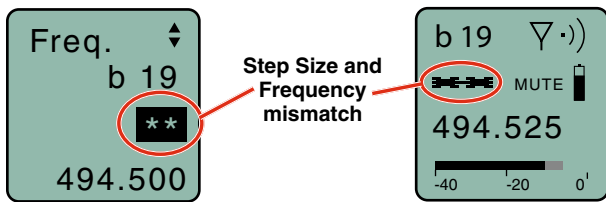

Helpful Features on Receivers

To aid in finding clear frequencies, several Lectrosonics receivers offer a **SmartTune** feature that scans the tuning range of the receiver and displays a graphical report that shows where RF signals are present at different levels, and areas where there is little or no RF energy present. The software then automatically selects the best channel for operation.

Lectrosonics receivers equipped with an **IR Sync** function allow the receiver to set frequency, step size and compatibility modes on the transmitter via an infrared link between the two units.

About Overlapping Frequency Bands

When two frequency bands overlap, it is possible to select the same frequency at the upper end of one and the lower end of the other. While the frequency will be the same, the pilot tones will be different, as indicated by the hex codes that appear.

In the following examples, the frequency is set to 494.500 MHz, but one is in band 470 and the other in band 19. This is done intentionally to maintain compatibility with receivers that tune across a single band. The band number and hex code must match the receiver to enable the correct pilot tone.

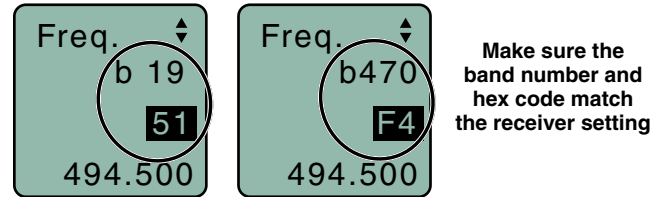

Selecting Audio Polarity (Phase)

Audio polarity can be inverted at the transmitter so the audio can be mixed with other microphones without comb filtering. The polarity can also be inverted at the receiver outputs.

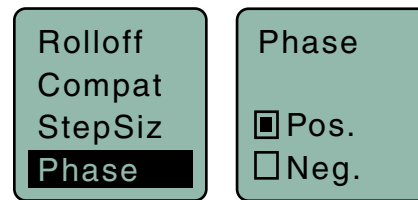

Selecting Battery Type

The voltage drop over the life of different batteries varies by type and brand. Be sure to set the correct battery type for accurate indications and warnings. The menu offers alkaline or lithium types.

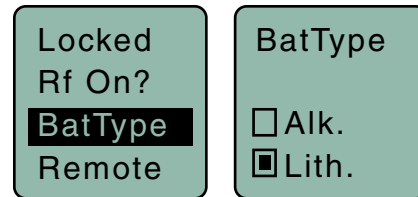

If you are using rechargeable batteries, it is better to use the timer function on the receiver to monitor the battery life rather than the indicators on the transmitter. The timer is available on all Lectrosonics Digital Hybrid Wireless® receivers. Rechargeable batteries maintain a fairly constant voltage across the operating time on each charge and stop working abruptly, so you will have little or no warning as they reach the end of operation.

Enabling Remote Control

Transmitter settings can be configured using special tones generated by a smartphone using a remote control application such as Lectro RM (available on the AppStore or Google Play). Enable this feature on the transmitter with the following menu items.

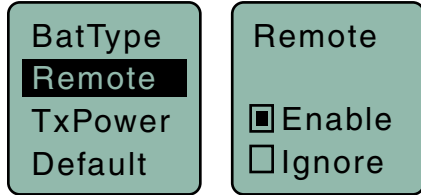

The following settings can be configured:

- Tx Input Gain
- Sleep/Unsleep
- Lock/Unlock
- Tx power output
- Frequency

Setting Transmitter Output Power

The output power can be set to 50 mW or 100 mW.

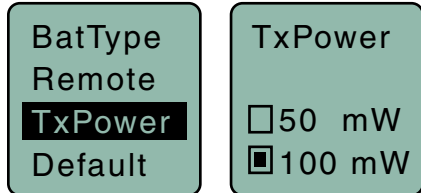

Restoring Default Settings

This is used to restore the factory settings.

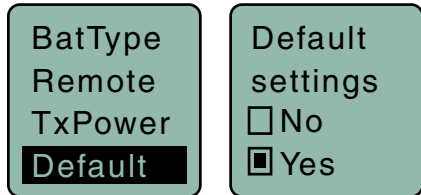

IR Sync Operation

A Lectrosonics receiver with IR Sync capability can transfer the settings for Frequency, Step Size and Compatibility mode to the transmitter via the IR ports. The transfer is triggered by a switch in the receiver. When the settings are successfully transferred, an confirmation will appear on the transmitter LCD.

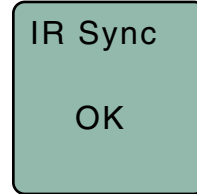

If a mismatch exists and the transfer cannot be completed, an error message will appear on the transmitter LCD indicating what the problem is.

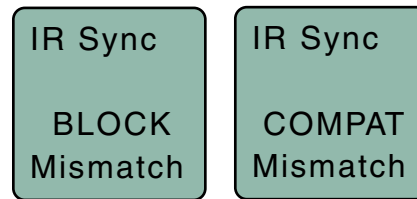

BLOCK Mismatch indicates that the transmitter and receiver are on different frequency blocks and the frequency cannot be set to match. **COMPAT Mismatch** will appear when the compatibility mode in the receiver is not available in the transmitters; for example, when you are trying to sync a US model to work an export model.

LectroRM

By New Endian LLC

LectroRM is a mobile application for iOS and Android operating systems. Its purpose is to remotely control Lectrosonics Transmitters, including:

- SM Series
- WM
- L Series

The app remotely changes settings on the transmitter through the use of encoded audio tones, which when received by the attached microphone, will alter the configured setting. The app was released by New Endian, LLC in September 2011. The app is available for download and sells for about \$20 on the Apple App Store and Google Play Store.

LectroRM's remote control mechanism is the use of an audio sequence of tones (dweedles) that are interpreted by the transmitter as a configuration change. The settings available in LectroRM are:

- Audio Level
- Frequency
- Sleep Mode
- Lock Mode

User Interface

The user interface involves selecting the audio sequence related to the desired change. Each version has an interface for selecting the desired setting and the desired option for that setting. Each version also has a mechanism to prevent accidental activation of the tone.

iOS

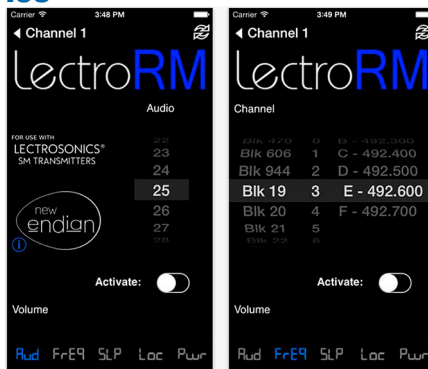

The iPhone version keeps each available setting on a separate page with the list of options for that setting. On iOS, the "Activate" toggle switch must be enabled to show the button which will then activate the audio. The iOS version's default orientation is upside-down but can be configured to orient right-side up. The purpose for this is to orient the device's speaker, which is at the bottom of the device, closer to the transmitter microphone.

Android

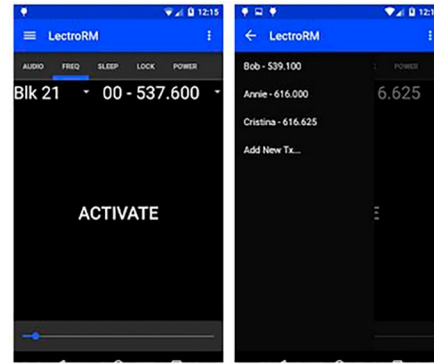

The Android version keeps all settings on the same page and allows the user to toggle between the activation buttons for each setting. The activation button must be long pressed to activate. The Android version also allows users to keep a configurable list of full sets of settings.

Activation

For a transmitter to respond to remote control audio tones, the transmitter must meet certain requirements:

- The transmitter must not be turned off; it can however be in sleep mode.
- The transmitter must have firmware version 1.5 or later for Audio, Frequency, Sleep and Lock changes.
- The transmitter microphone must be within range.
- The transmitter must be configured to enable remote control activation.

Please be aware this app is not a Lectrosonics product. It is privately owned and operated by New Endian LLC, www.newendian.com.

Accessories

P/N 26895	Wire belt clip
BCSLEBN	Spring-loaded belt clip
LTBATELIM	Battery eliminator; allows transmitter to be operated from external power; 6 to 36 VDC
M152/5P	Lavaliere microphone; omnidirectional
MI33PRA	Instrument cable; passive type for use with very high output pickups; right angle 1/4" plug
MI33PST	Instrument cable; passive type for use with very high output pickups; straight 1/4" plug
MI39AST	Instrument cable; active type for use with most instrument pickups; straight 1/4" plug
MC35	Line level adapter cable; XLR-F to TA5F; 37" length
MC41	Dynamic mic level adapter cable; XLR-F to TA5F; 37" length
MC49	Line level input cable; TA3F to TA5F; 12" length
MC47	Line level (-10dBv) input cable; RCA male to TA5F; 37" length

5-Pin Input Jack Wiring

The wiring diagrams included in this section represent the basic wiring necessary for the most common types of microphones and other audio inputs. Some microphones may require extra jumpers or a slight variation on the diagrams shown.

It is virtually impossible to keep completely up to date on changes that other manufacturers make to their products, thus you may encounter a microphone that differs from these instructions. If this occurs please call our toll-free number listed under Service and Repair in this manual or visit our web site at:

www.lectrosonics.com

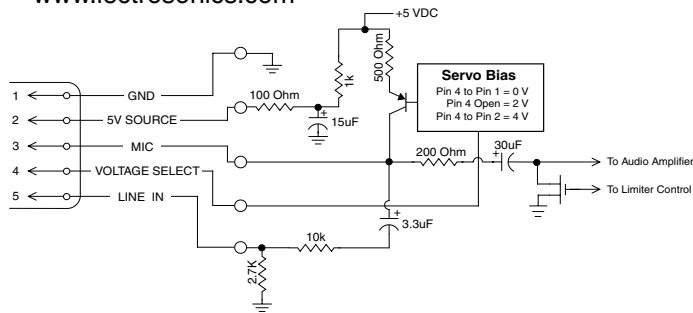

Audio input jack wiring:

PIN 1

Shield (ground) for positive biased electret lavalier microphones. Shield (ground) for dynamic microphones and line level inputs.

PIN 2

Bias voltage source for positive biased electret lavalier microphones that are not using servo bias circuitry and voltage source for 4 volt servo bias wiring.

PIN 3

Microphone level input and bias supply.

PIN 4

Bias voltage selector for Pin 3.

Pin 3 voltage depends on Pin 4 connection.

Pin 4 tied to Pin 1: 0 V

Pin 4 Open: 2 V

Pin 4 to Pin 2: 4 V

PIN 5

Line level input for tape decks, mixer outputs, musical instruments, etc.

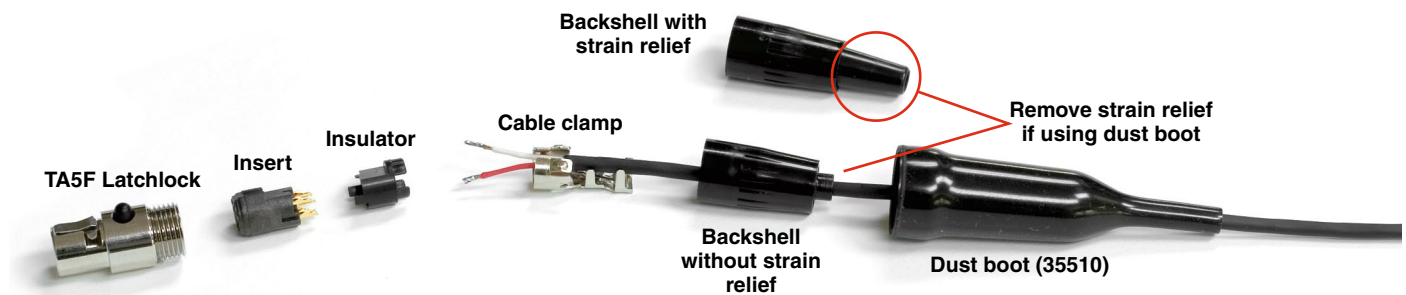

Note: If you use the dust boot, remove the rubber strain relief that is attached to the TA5F cap, or the boot will not fit over the assembly.

Installing the Connector:

- 1) If necessary, remove the old connector from the microphone cable.
- 2) Slide the dust boot onto microphone cable with the large end facing the connector.
- 3) If necessary, slide the 1/8-inch black shrink tubing onto the microphone cable. This tubing is needed for some smaller diameter cables to ensure there is a snug fit in the dust boot.
- 4) Slide the backshell over the cable as shown above. Slide the insulator over the cable before soldering the wires to the pins on the insert.
- 5) Solder the wires and resistors to the pins on the insert according to the diagrams shown in **Wiring Hookups for Different Sources**. A length of .065 OD clear tubing is included if you need to insulate the resistor leads or shield wire.
- 6) If necessary, remove the rubber strain relief from the TA5F backshell by simply pulling it out.
- 7) Seat the insulator on the insert. Slide the cable clamp over the end of the insulator and crimp as shown on the next page.
- 8) Insert the assembled insert/insulator/clamp into the latchlock. Make sure the tab and slot align to allow the insert to fully seat in the latchlock. Thread the backshell onto the latchlock.

Microphone Cable Termination for Non-Lectrosonics Microphones

TA5F Connector Assembly

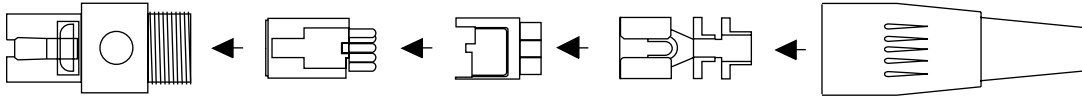

Mic Cord Stripping Instructions

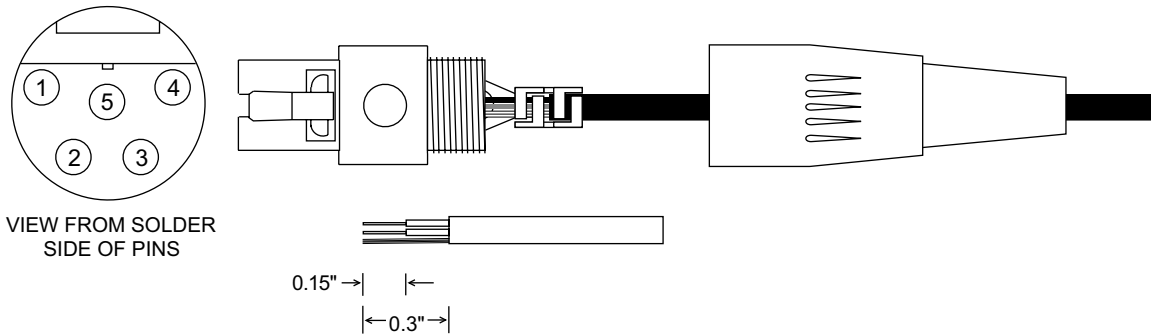

Crimping to Shield and Insulation

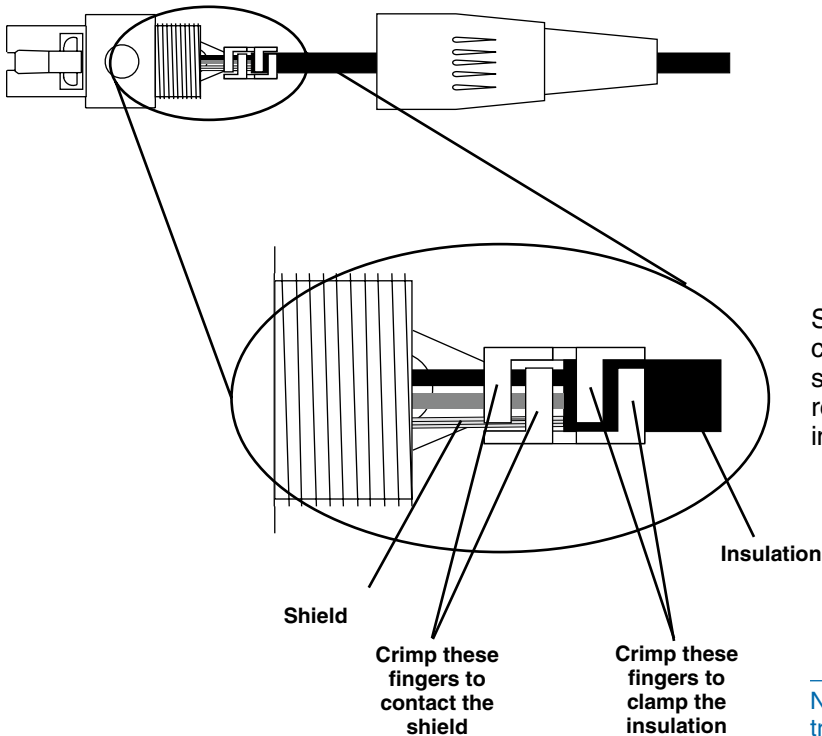

Strip and position the cable so that the clamp can be crimped to contact both the mic cable shield and the insulation. The shield contact reduces noise with some microphones and the insulation clamp increases ruggedness.

NOTE: This termination is intended for UHF transmitters only. VHF transmitters with 5-pin jacks require a different termination. Lectrosonics lavalier microphones are terminated for compatibility with VHF and UHF transmitters, which is different from what is shown here.

Input Jack Wiring for Different Sources

In addition to the microphone and line level wiring illustrated below, Lectrosonics makes a number of cables and adapters for other situations such as connecting musical instruments (guitars, bass guitars, etc.) to the transmitter. Visit www.lectrosonics.com and click on Accessories, or download the master catalog.

A lot of information regarding microphone wiring is also available in the FAQ section of the web site at:

www.lectrosonics.com > SUPPORT > FAQs

Follow the instructions to search by model number or other search options.

Compatible Wiring for Both Servo Bias Inputs and Earlier Transmitters:

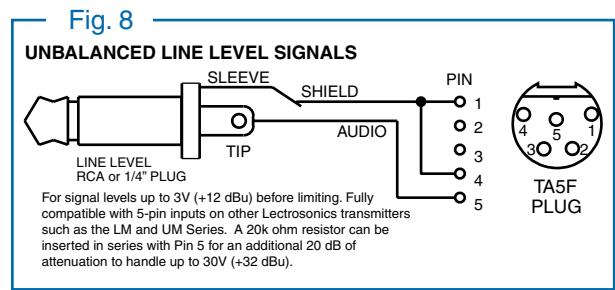
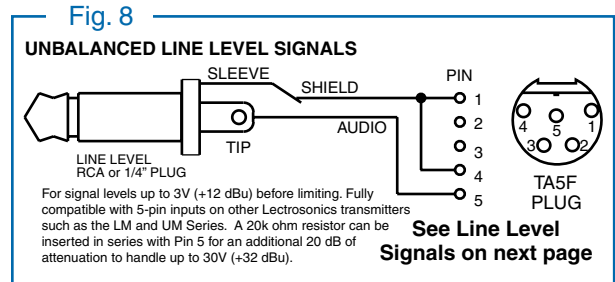
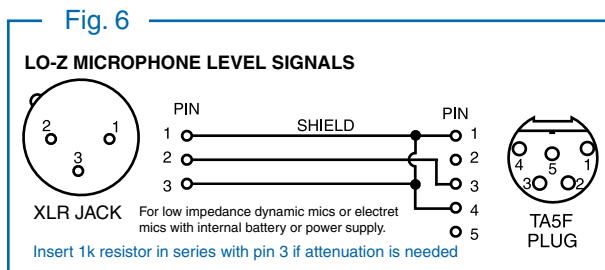
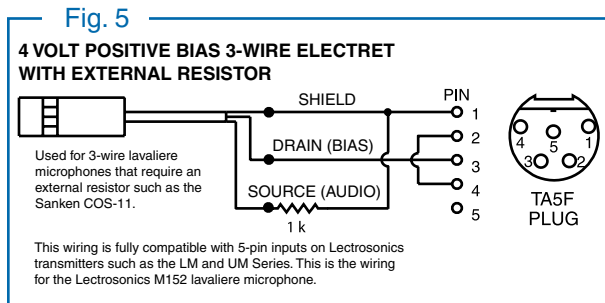
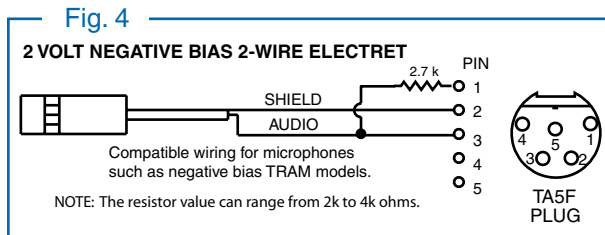
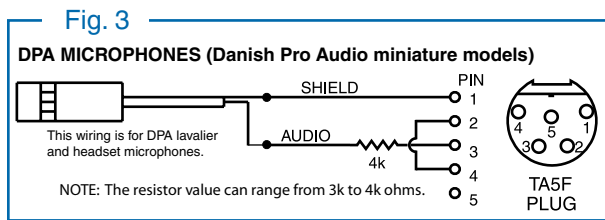
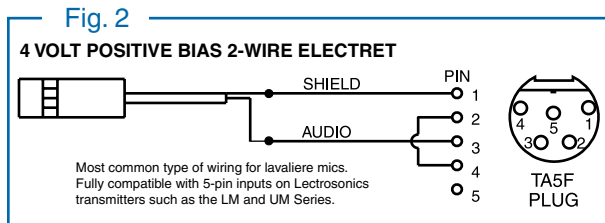
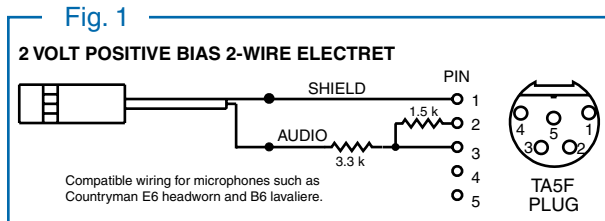

Simple Wiring for Servo Bias Inputs ONLY:

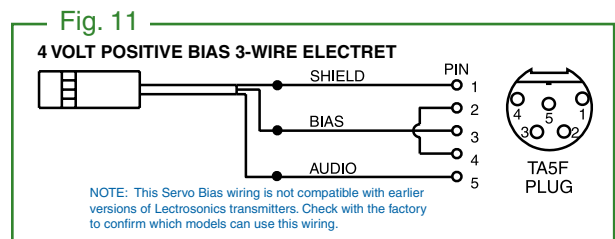
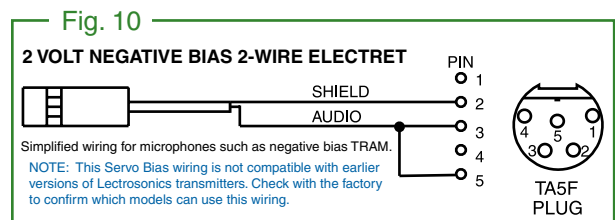
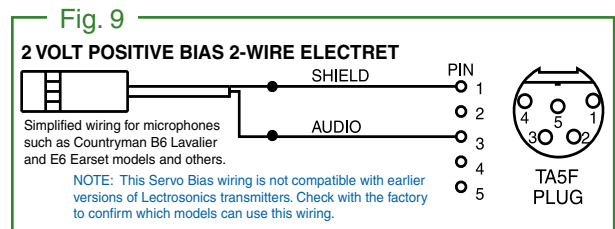

Microphone RF Bypassing

When used on a wireless transmitter, the microphone element is in the proximity of the RF coming from the transmitter. The nature of electret microphones makes them sensitive to RF, which can cause problems with microphone/transmitter compatibility. If the electret microphone is not designed properly for use with wireless transmitters, it may be necessary to install a chip capacitor in the mic capsule or connector to block the RF from entering the electret capsule.

Some mics require RF protection to keep the radio signal from affecting the capsule, even though the transmitter input circuitry is already RF bypassed.

If the mic is wired as directed, and you are having difficulty with squealing, high noise, or poor frequency response, RF is likely to be the cause.

The best RF protection is accomplished by installing RF bypass capacitors at the mic capsule. If this is not possible, or if you are still having problems, capacitors can be installed on the mic pins inside the TA5F connector housing. Refer to the diagram below for the correct locations of capacitors.

Use 330 pF capacitors. Capacitors are available from Lectrosonics. Please specify the part number for the desired lead style.

Leaded capacitors: P/N 15117

Leadless capacitors: P/N SCC330P

All Lectrosonics lavalier mics are already bypassed and do not need any additional capacitors installed for proper operation.

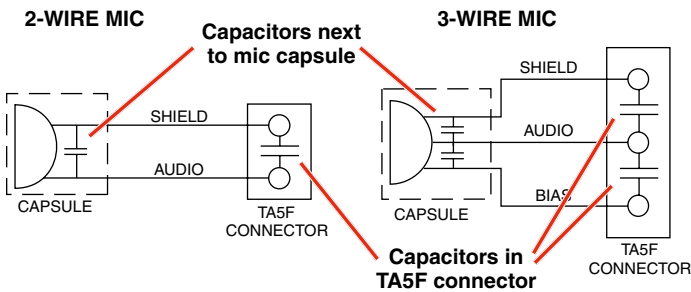

Line Level Signals

The wiring for line level and instrument signals is:

- Signal Hot to pin 5
- Signal Gnd to pin 1
- Pin 4 jumped to pin 1

This allows signal levels up to 3V RMS to be applied without limiting.

NOTE for line level inputs only (not instrument): If more headroom is needed, insert a 20 k resistor in series with pin 5. Put this resistor inside the TA5F connector to minimize noise pickup. The resistor will have little or no effect on the signal if the input is set for instrument.

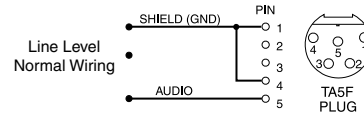

See Fig. 8 on previous page

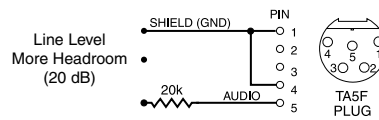

Firmware Update

Updating the firmware is a simple matter of downloading a utility program and file from the website and running the program on a **Windows operating system** with the transmitter connected to a computer via the USB port.

Go to www.lectrosonics.com/US. In the top menu, hover the mouse over Support, and click on Wireless Support. On the right-hand-side Wireless Support Menu, choose Wireless Downloads. Choose your product (LT), then choose Firmware.

Step 1:

Begin by downloading the USB Firmware Updater Program.



Below are links to the current firmware versions for the L-Series transmitters and receivers. These are zip files, after downloading extract it into a temporary folder. Use the **USB Firmware Updater program** to update firmware.

[Click here to see LR Firmware Revision History](#)

Special note regarding LT and LT/E01 firmware:

The LT and LT/E01 models require different firmware loads. The LT is sold in the US and Canada; the LT/E01 is sold in the European Union. Be sure to download the correct update file and double-check before installing!

Also, units with version 1.xx firmware currently installed can only be upgraded to the latest v1.xx firmware; units with version 2.xx firmware can only be upgraded to the latest v2.xx firmware. v1.xx and v2.xx firmware have identical features and functionality.

[Click here to see LT Firmware Revision History](#)

[Click here to see LT/E01 Firmware Revision History](#)

Special note regarding LMB and LMB/E01 firmware:

LMB and LMB/E01 are not capable of firmware updates in the field so no files are available for download. Below are links to the firmware revision history. Contact Lectrosonics or your local service center if you need to have firmware updates applied to these products.

[Click here to see LMB Firmware Revision History](#)

[Click here to see LMB/E01 Firmware Revision History](#)

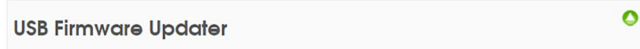

Below is a link to the current USB Firmware Updater installer. This program is used to update firmware on these products:

- DB transmitter
- LT transmitter
- LR receiver
- SSM transmitter
- HHa transmitter
- HMa transmitter

Instructions for updating firmware is found in the Instruction Manual for these products.

Download into a temporary folder. Uninstall any previous version of USB Firmware Updater before running the downloaded installer.

Note: This program requires that the FTDI D2XX Direct USB driver be installed on your PC. This is normally pre-installed but if not you will need to download and run a driver installer from the [official FTDI download page](#). Installers for both 64-bit and 32-bit Windows® PCs are available there.

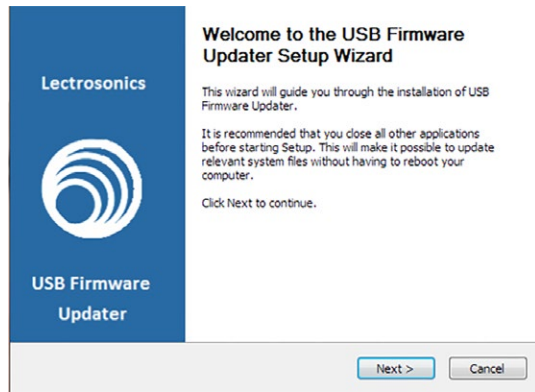

Step 2:

Next, test the Updater by opening the icon:  If the driver opens automatically, proceed to Step 3.

WARNING: If you receive the following error, the **FTDI I USB Device Driver is not installed on your system. Follow the TROUBLESHOOTING steps to fix the error.**

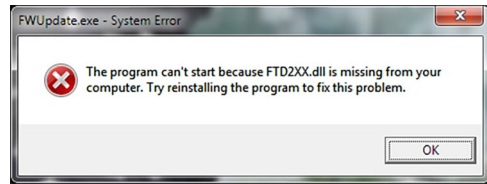

TROUBLESHOOTING:

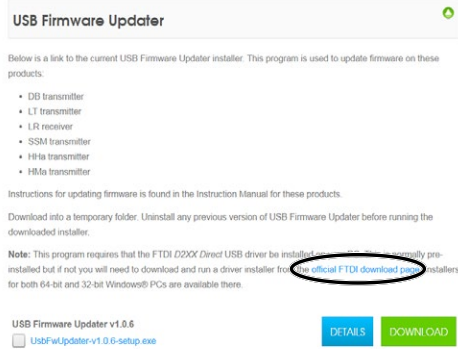

If you receive the FTDI D2XX error shown above, download and install the driver by clicking on this link.

Then click here to download.

NOTE: This website, <http://www.ftdichip.com/Drivers/D2XX.htm>, is not associated with Lectrosonics.com. It is a third party site used only for D2XX drivers currently available for Lectrosonics' devices' upgrades.

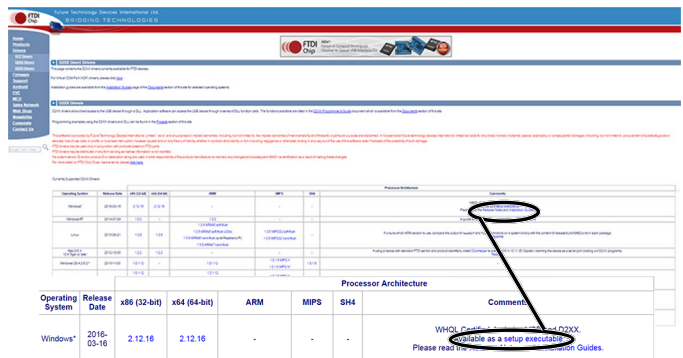

Step 3:

Refer to Step 1 to return to Firmware web page. Download Firmware Update and save to a local file on your PC for easy locating when updating.

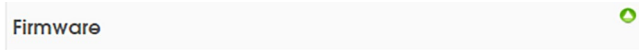

Below are links to the current firmware versions for the L-Series transmitters and receivers. These are zip files, after downloading extract it into a temporary folder. Use the [USB Firmware Updater program](#) to update firmware.

[Click here to see LR Firmware Revision History](#)

Special note regarding LT and LT/E01 firmware: The LT and LT/E01 models require different firmware loads. The LT is sold in the US and Canada; the LT/E01 is sold in the European Union. Be sure to download the correct update file and double-check before installing!

Also, units with version 1.xx firmware currently installed can *only* be upgraded to the latest v1.xx firmware; units with version 2.xx firmware can *only* be upgraded to the latest v2.xx firmware. v1.xx and v2.xx firmware have identical features and functionality.

[Click here to see LT Firmware Revision History](#)

[Click here to see LT/E01 Firmware Revision History](#)

Special note regarding LMB and LMB/E01 firmware:

LMB and LMB/E01 are not capable of firmware updates in the field so no files are available for download. Below are links to the firmware revision history. Contact Lectrosonics or your local service center if you need to have firmware updates applied to these products.

[Click here to see LMB Firmware Revision History](#)

[Click here to see LMB/E01 Firmware Revision History](#)

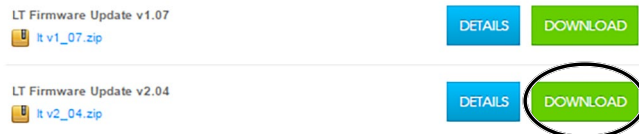

Step 4:

Open Lectrosonics USB Firmware Updater. 

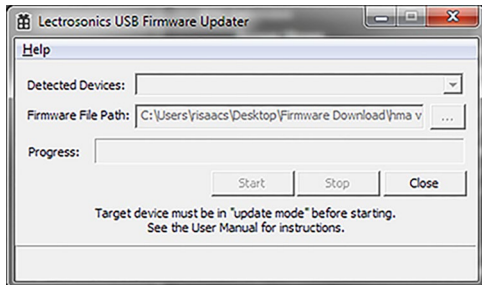

Step 5:



Put the transmitter in UPDATE mode by simultaneously holding down the **UP** and **DOWN** arrow buttons on the transmitter control panel while powering it up.

Step 6:

Using a microUSB cable, connect the transmitter to your PC.

Step 7:

In Lectrosonics USB Firmware Updater, choose the detected device, browse to local Firmware File and click Start.

NOTE: It may take up to a minute or so for the Updater to recognize the transmitter.

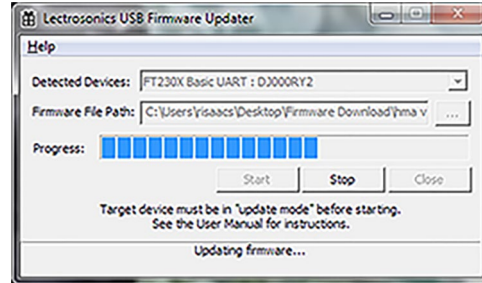

WARNING: Do not disrupt the microUSB cable during updating.

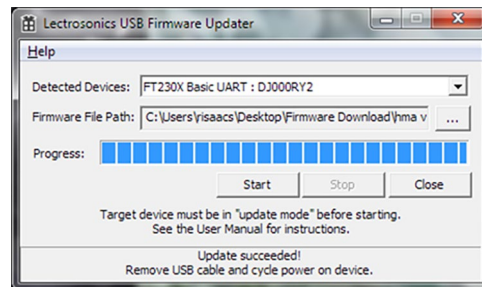

The Updater alerts with progress and completion.

Step 8:

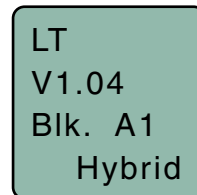

Once the Updater has completed, turn off the transmitter, then turn it back on to verify that the firmware version on the transmitter LCD matches the firmware version shown on the web site. The firmware is the second LCD display during boot up sequence.

Step 9:

Close Updater and disconnect microUSB cable.

Troubleshooting

Symptom:

Transmitter Battery LED off when Power Switch “ON”

No Transmitter Modulation LEDs when Signal Should be Present

Receiver Indicates RF But No Audio

Receiver RF Indicator Off

No Sound (Or Low Sound Level), Receiver Indicates Proper Audio Modulation

Distorted Sound

Wind Noise or Breath “Pops”

Hiss and Noise -- Audible Dropouts

Excessive Feedback (With Microphone)

It is important that you follow these steps in the sequence listed.

Possible Cause:

1. Batteries are inserted incorrectly.
 2. Batteries are low or dead.
1. Gain control turned all the way down.
 2. Batteries are inserted incorrectly. Check power LED.
 3. Mic capsule is damaged or malfunctioning.
 4. Mic cable damaged or miswired.
 5. Instrument Cable damaged or not plugged in.
 6. Musical instrument output level set too low.
1. Audio source or cable connected to transmitter is defective. Try using an alternate source or cable.
 2. Make sure the compatibility mode is the same on transmitter and receiver.
 3. Ensure musical instrument volume control is not set to minimum.
 4. Check for correct pilot tone indication on the receiver. See item on page 11 entitled **About Overlapping Frequency Bands**.
1. Ensure that the transmitter and receiver are set to the same frequency, and that the hex code matches.
 2. Transmitter not turned on, or battery is dead.
 3. Receiver antenna missing or improperly positioned.
 4. Operating distance is too great.
 5. Transmitter may be set to the Standby Mode. See page 8.
1. Receiver output level set too low.
 2. Receiver output is disconnected; cable is defective or miswired.
 3. Sound system or recorder input is turned down.
1. Transmitter gain (audio level) is too high. Check Modulation LEDs on transmitter and receiver while distortion is being heard.
 2. Receiver output level may be mismatched with the sound system or recorder input. Adjust output level on receiver to the correct level for the recorder, mixer or sound system.
 3. Transmitter and receiver may not be set to the same compatibility mode. Some mis-matched combinations will pass audio.
 4. RF interference. Reset both transmitter and receiver to a clear channel. Use scanning function on receiver if available.
1. Reposition microphone, or use a larger windscreen, or both.
 2. Omni-directional mics produce less wind noise and breath pops than directional types.
1. Transmitter gain (audio level) far too low.
 2. Receiver antenna missing or obstructed.
 3. Operating distance too great.
 4. RF interference. Reset both transmitter and receiver to a clear channel. Use scanning function on receiver if available.
 5. Musical instrument output set too low.
 6. Microphone capsule picking up RF noise. See item on page 20 entitled **Microphone RF Bypassing**.
1. Transmitter gain (audio level) too high. Check gain adjustment and/or reduce receiver output level.
 2. Microphone too close to speaker system.
 3. Microphone is too far from user’s mouth.

Specifications and Features

Operating Frequencies:

Band A1:	470.100 - 537.575
Band B1:	537.600 - 614.375
Band C1:	614.400 - 691.175

Frequency Selection Steps:	Selectable; 100 kHz or 25 kHz
RF Power output:	50 or 100 mW
Pilot tone:	25 to 32 kHz; 5 kHz deviation (Digital Hybrid mode)
Frequency Stability:	± 0.002%
Deviation:	± 75 kHz max. (Digital Hybrid mode)
Spurious radiation:	60 dB below carrier
Equivalent input noise:	-120 dBV (A-weighted)
Input level:	Nominal 2 mV to 300 mV, before limiting Greater than 1V maximum, with limiting.
Input impedance:	<ul style="list-style-type: none"> • Mic: 300 Ohm • Line: 2k Ohm
Input limiter:	DSP controlled, dual envelope "soft" limiter with greater than 30 dB range
Gain control range:	44 dB; digital control
Modulation indicators:	<ul style="list-style-type: none"> • Dual bicolor LEDs indicate modulation of -20, -10, 0 and +10 dB referenced to full modulation • LCD bar graph
Controls:	<ul style="list-style-type: none"> • Top panel toggle switch; programmable as power, mute, talkback or none (off) function • Side panel membrane switches with LCD interface for power on/off and all setup and configuration controls
Audio Input Jack:	Switchcraft 5-pin locking (TA5F)
Antenna:	Galvanized steel, flexible wire
Battery:	Two AA; alkaline, lithium, NiMH rechargeable
Battery Life:	<ul style="list-style-type: none"> • Duracell Quantum: 4.75 hours • Eneloop 2400 mAh NiMH: 5.5 hours
Weight:	5.8 ounces (141 grams), including lithium AA batteries and wire belt clip
Dimensions:	3.2 x 2.4 x .9 in. (81 x 61 x 20 mm)
Emission Designator:	180KF3E

Audio Performance (Digital Hybrid mode)

Frequency Response:

Mic input:	35 Hz to 20 kHz (+/-1dB); low frequency roll-off is selectable at 35, 50, 70, 100, 120, 180 Hz
Line/Instrument:	35 Hz to 20 kHz (+/-1dB)

THD: 0.2% (typical)

SNR at receiver output:	SmartNR	No Limiting	w/Limiting
	OFF	103.5	108.0
Note: The dual envelope "soft" limiter provides exceptionally good handling of transients using variable attack and release time constants. Once activated, the limiter compresses 30+ dB of transmitter input range into 4.5 dB of receiver output range, thus reducing the measured figure for SNR without limiting by 4.5 dB	NORMAL	107.0	111.5
	FULL	108.5	113.0

Specifications subject to change without notice.

For body worn operation, this transmitter model has been tested and meets the FCC RF exposure guidelines when used with the Lectrosonics accessories supplied or designated for this product. Use of other accessories may not ensure compliance with FCC RF exposure guidelines. Contact Lectrosonics if you have any questions or need more information about RF exposure using this product..

This device complies with FCC radiation exposure limits as set forth for an uncontrolled environment. This device should be installed and operated so that its antenna(s) are not co-located or operating in conjunction with any other antenna or transmitter.

This device complies with Industry Canada radiation exposure limits as set forth for a controlled "professional" use only.

Cet appareil est conforme avec les normes d'Industrie Canada concernant les limites d'exposition aux radiations pour un usage professionnel contrôlé seulement.

Service and Repair

If your system malfunctions, you should attempt to correct or isolate the trouble before concluding that the equipment needs repair. Make sure you have followed the setup procedure and operating instructions. Check the interconnecting cables and then go through the **Troubleshooting** section in this manual.

We strongly recommend that you **do not** try to repair the equipment yourself and **do not** have the local repair shop attempt anything other than the simplest repair. If the repair is more complicated than a broken wire or loose connection, send the unit to the factory for repair and service. Don't attempt to adjust any controls inside the units. Once set at the factory, the various controls and trimmers do not drift with age or vibration and never require readjustment. **There are no adjustments inside that will make a malfunctioning unit start working.**

LECTROSONICS' Service Department is equipped and staffed to quickly repair your equipment. In warranty repairs are made at no charge in accordance with the terms of the warranty. Out-of-warranty repairs are charged at a modest flat rate plus parts and shipping. Since it takes almost as much time and effort to determine what is wrong as it does to make the repair, there is a charge for an exact quotation. We will be happy to quote approximate charges by phone for out-of-warranty repairs.

Returning Units for Repair

For timely service, please follow the steps below:

- A.** DO NOT return equipment to the factory for repair without first contacting us by email or by phone. We need to know the nature of the problem, the model number and the serial number of the equipment. We also need a phone number where you can be reached 8 A.M. to 4 P.M. (U.S. Mountain Standard Time).
- B.** After receiving your request, we will issue you a return authorization number (R.A.). This number will help speed your repair through our receiving and repair departments. The return authorization number must be clearly shown on the **outside** of the shipping container.
- C.** Pack the equipment carefully and ship to us, shipping costs prepaid. If necessary, we can provide you with the proper packing materials. UPS is usually the best way to ship the units. Heavy units should be "double-boxed" for safe transport.
- D.** We also strongly recommend that you insure the equipment, since we cannot be responsible for loss of or damage to equipment that you ship. Of course, we insure the equipment when we ship it back to you.

Lectrosonics USA:

Mailing address:

Lectrosonics, Inc.
PO Box 15900
Rio Rancho, NM 87174
USA

Shipping address:

Lectrosonics, Inc.
581 Laser Rd.
Rio Rancho, NM 87124
USA

Telephone:

(505) 892-4501
(800) 821-1121 Toll-free
(505) 892-6243 Fax

Web:

www.lectrosonics.com

E-mail:

sales@lectrosonics.com

Lectrosonics Canada:

Mailing Address:

720 Spadina Avenue,
Suite 600
Toronto, Ontario M5S 2T9

Telephone:

(416) 596-2202
(877) 753-2876 Toll-free
(877-7LECTRO)
(416) 596-6648 Fax

E-mail:

Sales: colinb@lectrosonics.com
Service: joeb@lectrosonics.com

LIMITED ONE YEAR WARRANTY

The equipment is warranted for one year from date of purchase against defects in materials or workmanship provided it was purchased from an authorized dealer. This warranty does not cover equipment which has been abused or damaged by careless handling or shipping. This warranty does not apply to used or demonstrator equipment.

Should any defect develop, Lectrosonics, Inc. will, at our option, repair or replace any defective parts without charge for either parts or labor. If Lectrosonics, Inc. cannot correct the defect in your equipment, it will be replaced at no charge with a similar new item. Lectrosonics, Inc. will pay for the cost of returning your equipment to you.

This warranty applies only to items returned to Lectrosonics, Inc. or an authorized dealer, shipping costs prepaid, within one year from the date of purchase.

This Limited Warranty is governed by the laws of the State of New Mexico. It states the entire liability of Lectrosonics Inc. and the entire remedy of the purchaser for any breach of warranty as outlined above. NEITHER LECTROSONICS, INC. NOR ANYONE INVOLVED IN THE PRODUCTION OR DELIVERY OF THE EQUIPMENT SHALL BE LIABLE FOR ANY INDIRECT, SPECIAL, PUNITIVE, CONSEQUENTIAL, OR INCIDENTAL DAMAGES ARISING OUT OF THE USE OR INABILITY TO USE THIS EQUIPMENT EVEN IF LECTROSONICS, INC. HAS BEEN ADVISED OF THE POSSIBILITY OF SUCH DAMAGES. IN NO EVENT SHALL THE LIABILITY OF LECTROSONICS, INC. EXCEED THE PURCHASE PRICE OF ANY DEFECTIVE EQUIPMENT.

This warranty gives you specific legal rights. You may have additional legal rights which vary from state to state.

