

**SIGMA**

**fp**

# Thank you for purchasing the SIGMA fp.

- Please read this manual carefully so that you will learn how to use the product correctly. Be sure to read the SAFETY PRECAUTIONS on page 7 before using your camera.
- Please keep this instruction booklet handy for future reference. Doing so will allow you to understand and take advantage of the camera's unique features at any time.
- The warranty of this product is one year from the date of purchase. Warranty terms and warranty card are on a separate sheet, attached. Please refer to these materials for details.

## NOTES ON COPYRIGHT

---

This camera is intended only for personal use and should never be used in a way that infringes upon or contravenes international or domestic copyright laws and regulations. In addition, although it is intended purely for personal use, some restrictions may be applied to the photographing of demonstrations, performances, shows, exhibitions, or commercial properties, etc. Copyright or other legal rights should not be contravened.

- The SD, SDHC, and SDXC logos are trademarks of the SD-3C, LLC.
- DNG and CinemaDNG are either trademarks or registered trademarks of Adobe Systems Incorporated in the United States and/or other countries.
- HDMI, High-Definition Multimedia Interface, and HDMI Logo are trademarks or registered trademarks of HDMI Licensing Administrator, Inc. in the United States and other countries.
- QR Code is a registered trademark of DENSO WAVE INCORPORATED.
- All other company or product names used in documents are trademarks or registered trademarks of their respective holders.
- Element font designed by Ricoh CO., Ltd. is used for the display of the menu window of this camera.

**HDMI**<sup>®</sup>  
HIGH-DEFINITION MULTIMEDIA INTERFACE



## **Disposal of Electric and Electronic Equipment in Private Households**

Disposal of used Electrical & Electronic Equipment (Applicable in the European Union and other European countries with separate collection systems)

This symbol indicates that this product shall not be treated as household waste. Instead it shall be collected separately for the recycling of electrical and electronic equipment. If the new products are purchased, this product might be handed over to the distributor or the collection system of waste electrical and electronic equipment eventually. By ensuring this product is disposed of correctly, you will help prevent potential negative consequences for the environment and human health, which could otherwise be caused by inappropriate waste handling of this product or components of this product. If this product is disposed illegally, it might cause a possibility of penalties. For more detailed information about recycling of this product, please contact your local city office, your household waste disposal service or the shop where you have purchased the product.

## **PACKAGE CONTENTS / ACCESSORIES**

---

Please make sure that following standard accessories are included with your camera. If any of them is missing, contact the retailer from which you purchased your camera immediately.

1. Camera Body
  2. Body Cap (on the camera)
  3. Hot Shoe Unit HU-11
  4. Strap Holder (two)
  5. Strap
  6. Li-ion Battery BP-51
  7. AC Adapter UAC-11
  8. USB Cable (A-C) SUC-11
  9. Instruction Manual (this book)
  10. Limited Warranty
  11. Warranty Sticker
- No memory card is included with this camera. Please purchase this separately.

# TABLE OF CONTENTS

---





PACKAGE CONTENTS / ACCESSORIES.....	3
TABLE OF CONTENTS.....	4
SAFETY PRECAUTIONS.....	7
HANDLING PRECAUTIONS .....	10
SD MEMORY CARDS (OPTIONAL).....	11
ABOUT THE LENSES .....	12
ELECTRONIC SHUTTER.....	13
DESCRIPTION OF THE PARTS.....	14
MONITOR DISPLAY DURING SHOOTING .....	16
<b>PREPARATION.....</b>	<b>18</b>
ATTACHING THE CARRY STRAP.....	18
ABOUT HOT SHOE UNIT HU-11 .....	19
TO CHARGE THE BATTERY.....	20
MOUNTING AND REMOVING THE LENS.....	23
SETTING THE LANGUAGE.....	24
DATE, TIME AND AREA SETTING .....	25
CHECKING THE BATTERY STATUS.....	27
ABOUT TOUCH OPERATIONS .....	27
ABOUT CINE/STILL SWITCH.....	28
CAMERA SET-UP MENU .....	28
LIST OF MENU FUNCTIONS .....	31
QUICK SET MENU .....	36
CHANGING THE DISPLAY MODE.....	39
TO INSERT THE CARD.....	41
FORMATTING THE CARD .....	42
HOW TO PRESS THE SHUTTER BUTTON .....	42
QUICK PREVIEW.....	42
<b>DOING THE SHOOTING .....</b>	<b>43</b>
TAKING A PICTURE.....	43
SHOOTING A MOVIE .....	43
SELECTING THE EXPOSURE MODE.....	45
FOCUSING.....	51
HOW TO USE AUTOFOCUS.....	51

FOCUS MODE SETTING.....	51
FOCUS FRAME SETTING.....	53
FOCUSING USING MANUAL FOCUS.....	55
OTHER FOCUS SETTINGS.....	55
DRIVE MODE.....	63
STABILIZATION.....	66
ISO SENSITIVITY SETTING.....	67
ISO SENSITIVITY EXPANSION.....	67
ISO AUTO SETTINGS.....	69
IMAGE FILE SETTING.....	70
MOVIE RECORD SETTING.....	73
DC CROP (SUPER35) MODE.....	77
DIRECTOR'S VIEWFINDER.....	81
AUDIO RECORD SETTING.....	84
EXPOSURE COMPENSATION.....	85
METERING MODE.....	85
AEL BUTTON.....	86
WHITE BALANCE SETTING (WB).....	87
COLOR MODE.....	91
TONE CONTROL.....	94
FILL LIGHT.....	95
LENS OPTICS COMPENSATION.....	96
BRACKETING.....	98
HDR (HIGH DYNAMIC RANGE).....	103
CUSTOM MODE.....	104
SAVE / LOAD SETTINGS  .....	106
LOCK FUNCTION.....	109
USING THE EXTERNAL FLASH.....	109
FLASH MODE SETTING.....	110
FLASH EXPOSURE COMPENSATION.....	111
CHANGING OTHER SETTINGS.....	112
COLOR SPACE.....	112
LENS FUNCTION SETTINGS.....	112
FRAME GUIDE.....	113
DIAL SETTINGS.....	115









CUSTOM BUTTONS FUNCTIONS .....	116
SHUTTER BUTTON SETTINGS .....	117
<b>REVIEWING AND DELETING IMAGES .....</b>	<b>118</b>
VIEWING ONE IMAGE AT A TIME .....	118
MAGNIFYING IMAGES (STILL IMAGES ONLY) .....	119
VIEWING NINE IMAGES AT A TIME (CONTACT SHEET VIEW) ...	120
VIEWING IMAGE INFORMATION .....	120
DELETING FILES .....	123
DELETING A FILE WITH DELETE BUTTON .....	123
DELETE FILES FROM THE DELETE MENU .....	124
PLAYING BACK A MOVIE .....	125
OTHER REVIEWING FEATURES .....	127
FILTERING OPTIONS FOR DISPLAY .....	127
LOCK .....	127
MARKING IMAGES .....	129
ROTATING IMAGES .....	131
SLIDESHOW .....	132
DNG DEVELOPMENT .....	133
CINEMAGRAPH .....	134
EXPOSURE WARNING .....	138
IMAGE ROTATION .....	139
AEL BUTTON SETTINGS .....	139
SETTING FROM THE [SYSTEM] MENU .....	140
TRANSFERRING IMAGES TO A COMPUTER .....	156
USING THIS PRODUCT AS A WEB CAMERA .....	156
SCREENSHOT FEATURE .....	157
<b>REFERENCE .....</b>	<b>158</b>
OPTIONAL ACCESSORIES .....	158
USING AC ADAPTER SAC-7P (OPTIONAL) .....	160
MAINTENANCE .....	161
TROUBLESHOOTING .....	162
SPECIFICATIONS .....	165

# SAFETY PRECAUTIONS

To avoid causing damage or injury, please read this instruction manual carefully, before using the camera. Please take special note of the following two cautionary symbols.









-  **Warning !!** Using the product and disregarding this warning sign may cause serious injury or other dangerous results.
-  **Caution !!** Using the product disregarding this caution sign may cause injury or damage.
-  This symbol denotes a warning or point, where caution is required.
-  This Symbol contains information regarding the actions that must be avoided.

## **WARNING (BATTERY)**





-  Keep batteries in a safe place out of children's reach. If a battery is swallowed, call for emergency medical aid immediately.
-  Do not use any battery other than the designated battery types. Doing so may cause battery explosion, battery leakage, camera damage, injury or fire.
-  Do not use any battery other than that specified in this booklet. Otherwise, it might cause battery explosion, battery leakage, camera damage, injury or fire.
-  Avoid any shock, shake and drop. Ignoring this warning may cause battery explosion, or battery leakage, resulting in injury or fire.
-  Never disassemble, short circuit, heat, or put batteries into fire. Ignoring this warning may cause battery explosion, battery leakage, injury or fire.
-  Please only use charger with the dedicated battery. Charging other battery types causes battery explosion, battery leakage, camera damage, injury or fire.
-  If for some reason, the camera or batteries emit smoke, or if overheating or the smell of burning is detected, remove the batteries, taking care to avoid being burned. Take the camera to the retailer where you bought it, or to an authorized Sigma service station.
-  Please follow all guidelines, rules and regulations of your community regarding the disposal of batteries. If you do not use the camera for a long period of time, remove the battery.
-  Do not use any AC adapter other than the one provided with your camera. Using other brands may cause electrical shock and fire.

-  Keep batteries in a safe place out of children's reach. If a battery is swallowed, call for emergency medical aid immediately.

 **WARNING (BATTERY CHARGER AND AC ADAPTER)**

-  The battery charger is for indoor use only. Do not store the charger in humid or dusty locations.
-  Use it within the 0°C - 40°C temperature range only.
-  The AC Adapter is designed for use with this product only. Do not use it with any other appliance. Doing so may cause overheating, fire, electric shock or injury.
-  If the adapter is emitting smoke, generating a strange odor or making an abnormal noise, while in use, disconnect the power plug from the outlet immediately. Otherwise, fire or electric shock may result.
-  If water or a foreign object gets into the adapter, unplug from the AC outlet immediately. It could cause fire or electric shock.
-  Do not attempt to modify or disassemble this product. Doing so can cause fire or electric shock.
-  Do not place any heavy objects on the power cord, or pull it, bend it unduly, or heat it. It could damage the cord, and could cause fire or electric shock.
-  Do not use this product with AC voltage other than the specified power supply voltage AC110V - 240V (120V in U.S.A. and CANADA). Doing so could cause fire or electric shock.
-  Use a safety approved AC power cord as is specified by each country.

 **WARNING (CAMERA)**

-  Never use your camera in an environment where flammable or burnable, gas, liquids or chemicals, such as Propane, Gasoline, etc., are present.
-  Keep the camera in a safe place that children cannot reach. Playing with the camera strap around one's neck can cause strangulation.
-  Do not disassemble the camera; Doing so can cause electric shocks and burns.
-  Do not touch internal parts of the camera that become exposed as a result of damage, it could cause fire or electric shock. Remove the batteries and contact an authorized Sigma service station.



- 



#### **CAUTION (BATTERY CHARGER AND AC ADAPTER)**

- 



#### **CAUTION (CAMERA)**

-



If the liquid crystal display (LCD) monitor becomes damaged, be careful of the fragments of glass, which can cause injury. If the liquid inside the LCD monitor leaks out, and you are faced with the following situations, please do as follows.

- If the liquid adheres to clothes or the skin, wash it away with soap immediately.
- If the liquid enters the eye, flush the affected eye with clean water immediately for 15 minutes, and seek medical assistance.
- If the liquid is swallowed, drink a large quantity of water, induce vomiting and seek medical assistance.

## HANDLING PRECAUTIONS

---

### **Please read this section before using the camera.**

Study and familiarize yourself with the functions of your camera before using it. No compensation or guarantee is provided for unsatisfactory pictures or loss of profit, etc.

Carry spare batteries when you use the camera in a cold environment, on a field trip, or when taking many pictures at one time.

## ENVIRONMENT

---

- Your camera is a precision instrument. Do not drop it or subject it to physical shock.
- This camera benefits from a dust and splash proof construction. Although this construction enables the lens to be used under light rain, it is not the same as being water proof. Please pay attention to prevent a large amount of water from splashing on the camera, especially when using it by a waterside. It is often impractical to repair the internal mechanism and electric components if damaged by water.
- Do not leave the camera in a dusty, hot, or highly humid environment for a long period of time.
- If the camera is moved from a cold place to a warm room, water droplets may appear on the camera. Please keep the camera in a bag until it is acclimatized to the ambient room temperature.

- The camera will work within a temperature range between 0°C/32°F and +40°C/104°F and humidity less than 85% (no condensation). However, in cold temperatures below 0°C, the power performance of the battery is reduced. Please carry a spare battery in these circumstances, and keep the batteries warm.
- Static electricity or magnetic fields may affect the operation of the camera. If such exposure occurs, please remove the battery from the camera and re-insert it, to reset the camera's microprocessors.

## DURING PROLONGED USE

---

- Although there are cases where the surface of camera gets hot, this is not a malfunction.
- If you use the camera for an extended period of time, the camera may get hot and the warning mark (🔥⚠️) will be displayed. If the camera gets too heat, a warning message will be displayed and the camera will turn off automatically.
- If the camera turns off, please leave it switched off for more than ten minutes to lower its temperature.
- Image quality may lower when the camera gets hot. If the warning mark (🔥⚠️) is displayed, we recommend turning off the camera and wait until the temperature of the camera becomes lower.
- When you use a USB storage device, such as an SSD card, to shoot a movie, the USB storage may become hot and movie recording may stop.

## SD MEMORY CARDS (OPTIONAL)

---

This product supports the following memory cards that comply with the SD standards.

SD, SDHC, and SDXC memory cards
---------------------------------

- In this instruction manual, these memory cards are referred to as the 'Card' or 'SD card'.
- This product is compatible with SDHC and SDXC memory cards based on the UHS-I or UHS-II standards.

- For movie shooting, an SD card may not be available depending on the bit rate. For details on compatible media, refer to "BIT RATE AND COMPATIBLE MEDIA" (P.75).
- SD cards have a write protection switch, which prevents the card from being accidentally written to or formatted. Moving the switch to the 'LOCK' position prevents accidental erasure of files.
- Do not leave the card in direct sunlight or near a heating device.
- Avoid storing cards in environments of high temperature and humidity or where static electricity or electromagnetic fields may be generated.
- For proper usage of the card, please refer to their instruction manuals.
- The "Delete" feature of the Camera and PC may not delete the data in the memory card completely. Some data might still remain. If you wish to remove all data from card securely, please use third party software.

## ABOUT THE LENSES

This camera uses the L-Mount. Your camera can use interchangeable lenses for L-Mount.

- This camera has a 35mm full-frame image sensor. In order to take full advantage of the capability of the image sensor, it is recommended that L-Mount lenses are used for full size format. You can use lenses for APS-C format in DC Crop mode, which limits the recording area of the image sensor for APS-C size.
- Sigma MC-21 Mount Converter (optional) allows you to use Sigma SA mount interchangeable lenses or Sigma interchangeable lenses for Canon EF mount.
- Depending on the release date of the lens, updating the lens firmware may be required. It may also be necessary to update the camera firmware. Please check our website for the latest information about the corresponding lens.

**[sigma-global.com/en/cameras/fp/](http://sigma-global.com/en/cameras/fp/)**

## ELECTRONIC SHUTTER





This product is not equipped with a mechanical shutter mechanism. It provides an electronic shutter that electronically controls the image sensor to adjust the exposure time.

The electronic shutter enables the high-speed shutter speed and high-speed continuous shooting with no noise or vibration. However, the electronic shutter has disadvantages, so be sure to note the following points.

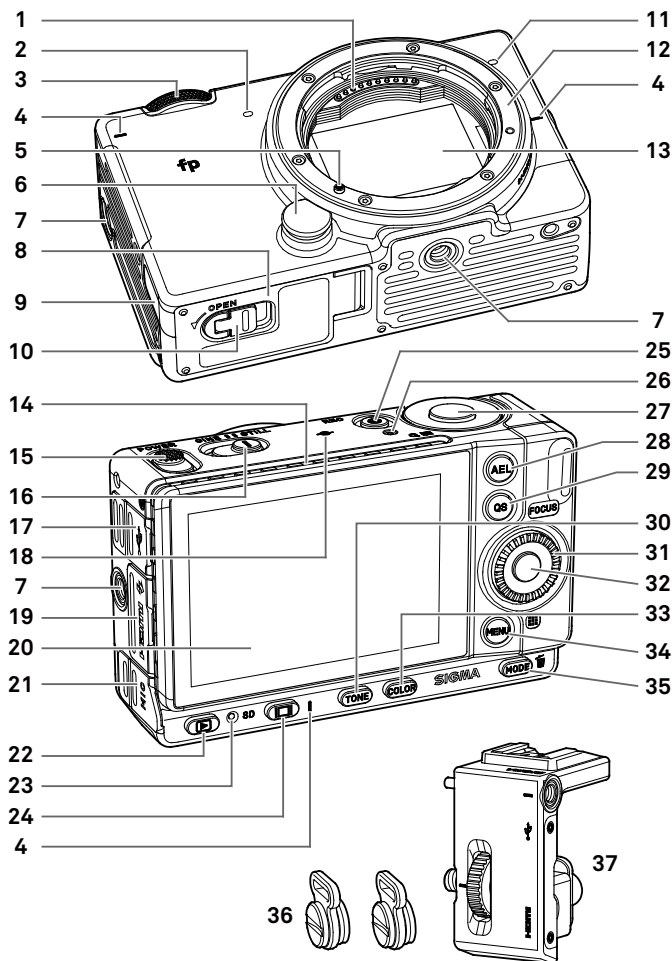
- Uneven exposure can easily occur under a flickering light source such as a fluorescent light, so use the slower shutter speed.
- The flash tuning speed is set to 1/30 sec. or less (1/15 sec. or less when the image quality is set to DNG and DNG + JPEG and the memory bit count is 14 bits). When shooting with the flash using manual exposure, set the shutter speed to 1/30 sec. or less (1/15 sec. or less).
- When shooting a fast-moving subject, distortion may occur.

# DESCRIPTION OF THE PARTS



1	Lens Signal Contacts	20	LCD Monitor / Touch Panel
2	Microphone (Right)	21	Microphone / Cable Release Terminal
3	Front Dial	22	 (View) Button
4	Position Index for Tripod Socket	23	Busy Lamp
5	Lens Mount Index / Lens Lock Pin	24	 (Display) Button
6	Lens Lock Button	25	REC Button
7	Tripod / Strap Holder Sockets	26	REC Lamp
8	Battery / SD Card Cover	27	Shutter Button
9	DC Connector Cover	28	<b>AEL</b> Button
10	Battery / SD Card Cover Latch	29	<b>QS</b> (Quick Set) Button
11	Microphone (Left)	30	Tone Control Button
12	Lens Mount	31	Rear Dial
13	Image Sensor / Dust Protector	32	 (OK) Button
14	Heatsink	33	Color Mode Button
15	Power Switch	34	<b>MENU</b> (Menu) Button
16	CINE / STILL Switch	35	<b>MODE</b> (Shooting Mode) /  (Delete) Button
17	USB Terminal (Type C USB 3.0) / Charge lamp	36	Strap Holders
18	Focal Plane Mark	37	Hot Shoe Unit HU-11
19	HDMI Terminal (Type D (Version 1.4)) / HU-11 Contacts		

## CAUTION

- Be careful not to touch the dust protector (image sensor protective glass)(13).





## In CINE mode (STILL-like style)

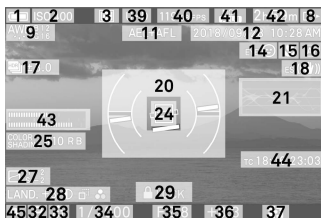

1	Battery Level Indicator	27	Tone Control *
2	ISO Sensitivity	28	Color Mode / (Toning Effect)
3	DC Crop Mode *	29	Locked State Indicator *
4	Image Size	30	Interval timer *
5	Aspect Ratio	31	Focus Indicator
6	Image Quality	32	Exposure Mode
7	Number of shots remaining	33	Custom Mode *
8	Memory Media	34	Shutter Speed
9	White Balance	35	F Number / T Number
10	Camera Shake Warning	36	Exposure Compensation Value / Exposure Meter
11	AE Lock / AF Lock *	37	Metering Mode
12	Date / Time *	38	Number of shots remaining before memory buffer full
13	Drive Mode	39	Resolution
14	Face / Eye Detection AF *	40	Frame Rate
15	Focus Limiter *	41	Format / Bit Depth / Compression
16	Focus Mode	42	Max Record Time
17	Exposure BKT *	43	Audiometer
18	Electronic Stabilization *	44	Time Code
19	Auto Bracketing / HDR *	45	Focus / REC Indicator
20	Electronic Level *	46	Recording
21	Histogram / Waveform *	47	Camera ID, Reel Number-Take Number
22	Flash Mode *	48	Focus Distance *
23	Flash Exposure Compensation value *	49	Focal Length *
24	Focusing Frame	50	Center Mark *
25	Color Shading Correction *	51	Shutter Angle / Shutter Speed
26	Fill Light *		

\* Displayed only during setting.



This icon is displayed while image processing is being performed in the camera just after shooting. While this icon is displayed, it may not be possible to operate the camera.



This icon indicates that the camera is still shooting with a slow shutter speed.

## PREPARATION

### ATTACHING THE CARRY STRAP

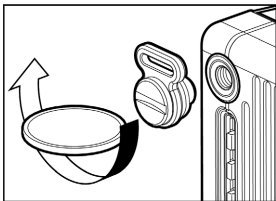

Using a coin, attach the supplied strap holders securely to the tripod/strap holder sockets on both sides of the camera.

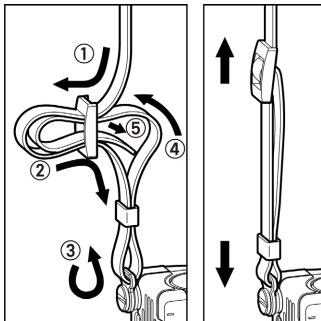

Undo both ends of the supplied strap and attach it to the right and left strap holders as shown.

### WARNING

- Before taking a picture, make sure the strap holders are firmly screwed into the sockets. If either or both of the strap holders come loose, the camera may fall during use. If either of them do come loose, firmly tighten it using a coin or similar object.

## ABOUT HOT SHOE UNIT HU-11

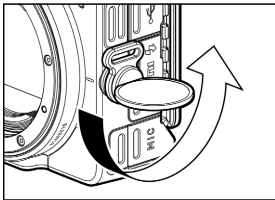

When using the flash, attach the hot shoe unit HU-11, which is supplied with this product, to the camera.

**1**

If the strap holder is attached to the left side of the camera, remove it using a coin or similar object.

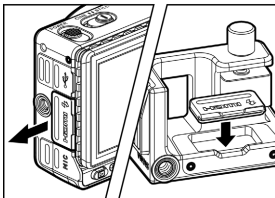

**2**

Remove the contact cover and place it in the contact cover holder on HU-11.

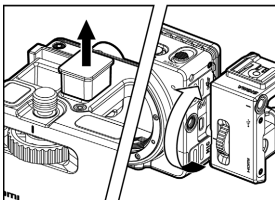

**3**

Remove the contact protection cap on HU-11 and attach HU-11 securely to the camera by turning the locking ring.

- Use the EF-630 SIGMA Electronic Flash (FOR SIGMA) (P.158) or EF-140S SA-STTL (P.159) with your camera.

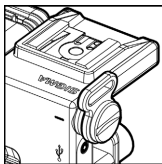

The strap holders removed from the camera can be attached to the strap holder sockets on HU-11.

### WARNING

- Before taking a picture, make sure the strap holders are firmly screwed into the sockets. If either or both of the strap holders come loose, the camera may fall during use. If either of them do come loose, firmly tighten it using a coin or similar object.

## HDMI CABLE LOCK

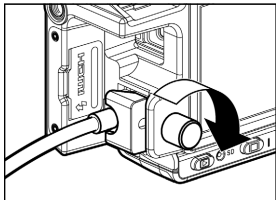

HU-11 comes with an HDMI cable lock that prevents the HDMI cable from being disconnected when shooting images.

Connect the HDMI cable to the HDMI terminal on your camera and secure the cable using the cable locking screw.

## TO CHARGE THE BATTERY

Insert the supplied lithium-ion rechargeable battery, BP-51 battery pack, (hereafter, battery) into the camera. Connect the supplied UAC-11 AC adapter to charge the battery. Charge the battery before using the camera for the first time.

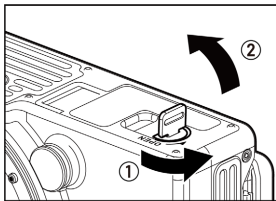

**1**

Make sure that the power switch is set to OFF. Rotate the battery/SD card cover latch to open the cover.

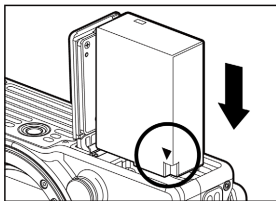

**2**

Insert the battery until it locks into place.

**3**

Close the battery compartment cover and lock the cover by turning the battery/SD card cover latch.

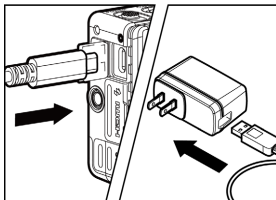

**4**

Open the terminal cover and connect the camera to the AC adapter using the USB cable provided with the camera.

- Make sure that the cable is connected in the correct orientation.

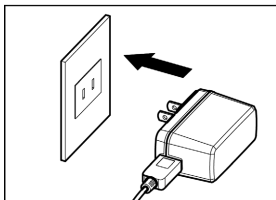

**5**

Insert the AC adapter into the power outlet.

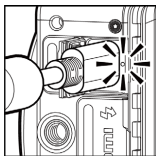

- When charging is in progress, the charge lamp will light up yellow-green.
- It takes about 240 minutes to recharge the battery.
- The time required to recharge the battery depends on the ambient temperature and the status of the recharge level.

**6**

When the charge lamp goes out, charging is completed.

### If the charge lamp flashes

- The battery temperature is too high or too low. We recommend charging in a location where the ambient temperature is between 10°C and 30°C.
- Wipe the battery contacts with a clean, dry cloth.

### CAUTION

- The battery cannot be charged when the camera is turned on. Be sure to turn off your camera before charging.
- If the number of images that can be taken on a single charge is significantly reduced, the battery is reaching the end of its lifespan. Replace it with a new one.

- The battery can be charged with BC-71 battery charger (optional). (P.159)
- The supplied AC adapter is provided for charging the battery. To operate the camera on 100 VAC, please purchase the SAC-7P AC adapter set (optional). (P.159)

## CHARGING THE BATTERY THROUGH THE COMPUTER

Connect the camera to a computer using the supplied USB cable.

- The battery cannot be charged when the camera is turned on. Be sure to turn off your camera before charging.
- Be sure to connect the USB cable to the USB socket on your computer. Do not connect it to the USB socket of a monitor, keyboard, or USB hub.
- If the computer enters Sleep mode during charging, charging may be stopped.
- The time required to charge varies depending on the performance of the computer.

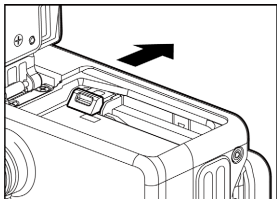

## TO REMOVE THE BATTERY

Slide the battery compartment cover latch and remove the battery.

## WARNING

- Do not remove the battery or memory card while the Busy Lamp is on or flashing. Otherwise, the written data will be lost. This could also damage the camera and/or memory card.

## MOUNTING AND REMOVING THE LENS

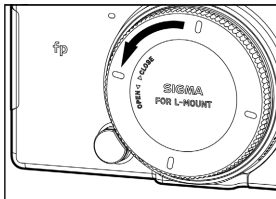

**1**

Turn the power switch to OFF.

**2**

Remove the lens's rear cap and the camera's body cap.

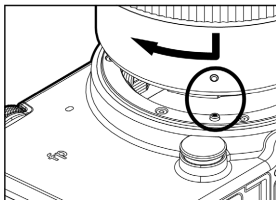

**3**

Align the lens mount index on the camera with the index on the lens. Insert the lens into the mount of the camera and rotate the lens clockwise until it clicks into the locked position.

### CAUTION

- To ensure the lens fits correctly, do not press the lens lock button while attaching the lens. Make sure that the lens is locked in place.

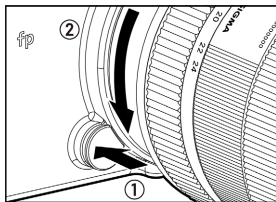

To remove the lens, press the lens lock button and turn the lens counter-clockwise until it stops. Gently remove the lens from the camera body.

### CAUTION

On the mount surface of the lens, there are a number of electrical contacts. Scratches or dirt may cause the camera to malfunction.

## SETTING THE LANGUAGE

The default language displayed on the LCD monitor is English. The language can be changed using **[Language / 言語]** in the Set-up menu.

### For when the camera used for the first time

When the camera is switched on for the first time, select a language on the display. Press **◀▶** buttons and confirm the language by pressing the **OK** button.

After selecting a language, input the date and time on the display. For the details of settings, refer to the instructions in **"DATE, TIME AND AREA SETTING"** on the page 25 of the instruction manual, from the section number **3** onward.

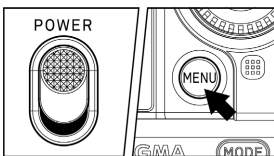

**1**

Turn the camera on.

**2**

Press the **MENU** button on the back of the camera to display the Camera Set-up Menu. (See P.29)

**3**

Select **[SYSTEM (5)]** by rotating the Front Dial.

**4**

Use the **◀▶** buttons to select **[Language / 言語]**.

**5**

Press the **OK** or **>** button to open the language set-up page.

**6**

Use the **◀▶** buttons to select the desired language.

**7**

Press the **OK** button to apply the setting or the **MENU** button to return to the language set-up page without making any changes.





## Selectable languages

English	English (Default)
日本語	Japanese
Deutsch	German
Français	French
Español	Spanish
Italiano	Italian
简体中文	Simplified Chinese
繁體中文	Traditional Chinese
한국어	Korean

Русский	Russian
Nederlands	Dutch
Polski	Polish
Português	Portuguese
Dansk	Danish
Svenska	Swedish
Norsk	Norwegian
Suomi	Finnish

## DATE, TIME AND AREA SETTING



When the camera is being used for the first time or if it has not been used for a long time, set the correct date, time, and area.

**1**

Press the **MENU** button on the back of the camera to display the Camera Set-up Menu. (See P.29)

**2**

Select [**SYSTEM**] → [**Date/Time/Area**].

**3**

Press the **>** button or **OK** button in [**Time Zone**], use the **⬆** button to select your area, and press the **>** button or **OK** button to confirm.



- If your area is not listed, check the time difference between your zone and the UTC time zone, and select an area in the list with the same time difference.

**4**

Set the daylight saving time (summer time) as needed. Select [**Off**] or [**On** (☀)] from [**Summer Time**].



5

In the Date/Time area, press the **>** button or **OK** button to set the Date/Time.



6

Press the **<>** button to select an item and change it by pressing the **◇** button.

7

Press the **OK** button to apply the setting or the **MENU** button to return to the date/ time set-up page without making any changes.

## CAUTION

- The camera's internal clock is powered by a capacitor that receives its charge from camera's battery. If the camera is without battery for an extended period of time, such as after prolonged storage, the internal clock will need to be reset.
- If you change [**Summer Time**] after you have set the time, the time you set is shifted by one hour.

## TO CHANGE THE ORDER OF THE DATE

The date can be displayed in one of three formats: M/D/Y (month/day/ year), D/M/Y (day/month/year), or Y/M/D (year/month/day).

Select your desired display order in [**Date Format**].

## TO SWITCH 24 HOUR AND 12 HOUR (AM/PM) DISPLAY

Select your desired time format in [**Time Format**].

## CHECKING THE BATTERY STATUS

The battery icon, which shows the capacity of the battery, is shown on the left corner on the color LCD panel. Please take notice of the battery status before and when in use.



	The power of the battery is insufficient, replace or recharge the battery immediately.
 (Red)	The power of the battery is empty; the camera will no longer work. Replace or recharge the battery immediately.
	Camera is operating on household power or an external battery.

### CAUTION

- If you connect a USB storage such as SSD, the battery capacity display will change because the battery consumption will increase.

## ABOUT TOUCH OPERATIONS

You can operate some of the functions on the touch panel.

The touch operations are described below:

<b>Tap</b>	Touch lightly with your finger and then raise your finger.
<b>Double tap</b>	Tap twice in succession.
<b>Drag</b>	Touch and then move your finger while still touching.
<b>Flick</b>	Touch and move your finger rapidly while still touching.
<b>Pinch Out</b>	Touch with two fingers and then move fingers further apart.
<b>Pinch In</b>	Touch with two fingers and then move fingers closer together.

- For details on touch panel settings, refer to [TOUCH OPERATION] (P.148).

## ABOUT CINE/STILL SWITCH

This camera can shoot still images and movies. Depending on the position of the CINE/STILL switch, the camera can be used as a camera dedicated for shooting both still images and movies.

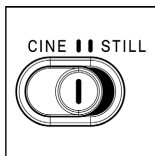

To shoot still images, select STILL (STILL mode). To shoot movies, select CINE (CINE mode).

## CAMERA SET-UP MENU

This section describes the various settings in the Camera Set-up menu. You can set detailed functions and basic camera settings from the Camera Set-up menu screen.

- Available menu items in the Set-up menu vary depending on the position of the CINE/STILL switch.

DC Crop Mode	Auto
Image Settings <b>(STILL)</b>	... >
Aspect Ratio <b>(STILL)</b>	3:2

The "**STILL**" icon is displayed for still-image dedicated items, still-image dedicated options, and items containing still-image dedicated options.

DC Crop (Super 35) Mode	Auto
Record Settings <b>(CINE)</b>	... >
Audio Record <b>(CINE)</b>	On

The "**CINE**" icon is displayed for movie-dedicated items, movie-dedicated options, and items containing movie-dedicated options.

- In this manual, "**(STILL)**" is provided for still-dedicated items or options, and "**(CINE)**" for the movie-dedicated items or options.
- There are items that can be set separately for "**STILL**" and "**CINE**" even though they are the same. (In this manual, items that are able to be independently set are indicated by "**(CINE/STILL)**".) Select your desired mode by using the CINE/STILL switch before setting detailed functions and basic camera settings.

## TO DISPLAY THE SET-UP MENU

Press the **MENU** button on the back of the camera.

Press the **MENU** button again to close the Set-up menu.

### Tab area



### Move to another page

Each time the Front Dial is rotated, the screen moves to the next tab.

(When the tab area is selected, it is possible to change the setting menu by pressing the  $\leftarrow$   $\rightarrow$  buttons as well.)

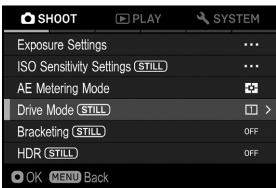

### While in the Set-up Menu:

Use the  $\diamond$  buttons or the Rear Dial to select the desired item.

Press the  $\rightarrow$  or **OK** button to open a sub-menu.

Depending on the item, a menu screen, a confirmation dialog or second-level items may be displayed.

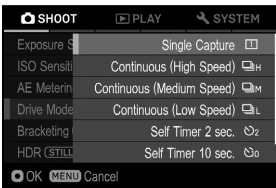

### While in the sub-menus:

Use the  $\diamond$  buttons or the Rear Dial to select the desired option.

Press the  $\rightarrow$  or **OK** button to apply the setting.

(Press the  $\leftarrow$  or **MENU** button to close sub-menus without changes being applied.)





The second-level items may be further divided into pages. Use the  $\leftarrow$   $\rightarrow$  buttons or the Front Dial to move to other tabs. To exit the tab, press the **MENU** button.

## THE CAMERA SET-UP MENU IS DIVIDED INTO THREE GROUPS.



### / **SHOOT (CAPTURE SETTINGS)** (Blue Tab)

Set the shooting function. If the **MENU** button is pressed during the shooting mode, the [ **SHOOT**] menu opens when the CINE/STILL switch is set to the [**STILL**] position, and the [ **SHOOT**] menu opens when the CINE/STILL switch is set to the [**CINE**] position.



### **PLAY (PLAYBACK)** (Red Tab)



Set the playback function. If the **MENU** button is pressed during playback mode, the [ **PLAY**] menu opens.



### **SYSTEM (CAMERA SETTINGS)** (Yellow Tab)

Set the basic status of the camera. Press the **MENU** button to open the Camera Set-up menu, and turn the Front Dial or the Rear Dial to move to the [ **SYSTEM**] menu.

## TIP

- Depending on the camera settings, some menu items and setting options cannot be selected. They will be grayed out.
- If you press the  or **OK** button on the item or option that is grayed out in [ /  **SHOOT**], a list of causes that cannot be set will be displayed. Review the camera settings by referring to the displayed contents.

## LIST OF MENU FUNCTIONS

For more information about each menu item, refer to the appropriate pages.

\* **C** = CINE mode, **S** = STILL mode

### / SHOOT(1)

Menu Item	Second-level Menu Item	C	S	Page
Exposure Settings	Shooting Mode		○	45
	Shutter Speed		○	47,48
	Shutter Angle	○	-	47,48
	Shutter Mode	○	-	45
	Aperture		○	46,48
	Exposure Compensation		○	85
ISO Sensitivity Settings	ISO Sensitivity		○	67
	ISO Sensitivity Step		○	67
	ISO Sensitivity Expansion		○	67
	ISO Auto Settings	○	○	69
AE Metering Mode	-		○	85
Drive Mode	-	-	○	63
Bracketing	Exposure	-	○	98,99
	Focus	-	○	98,100
	White Balance	-	○	98,101
	Color Mode	-	○	98,102
	Fill Light	-	○	98,103
HDR	-		○	103

### / SHOOT(2)

Menu Item	Second-level Menu Item	C	S	Page
DC Crop Mode	-		○	77
Image Settings	Image Quality	-	○	70
	DNG Quality	-	○	70
	Image Size	-	○	71
Aspect Ratio	-	-	○	72

Menu Item	Second-level Menu Item	C	S	Page
Record Settings	Format	○	-	73
	Bit Depth (CinemaDNG)	○	-	73
	Compression (MOV)	○	-	74
	Resolution	○	-	74
	Frame Rate	○	-	74
Audio Record	-	○	-	84

### / SHOOT(3)

Menu Item	Second-level Menu Item	C	S	Page
White Balance	-	○		87
Color Settings	Color Mode	-	○	91
	Color Space	-	○	112
Color Mode	-	○	-	91
Tone Control	-	○		94
Fill Light	-	-	○	95
Lens Optics Compensation	Distortion	○		96
	Lateral Chromatic Aberration	○		96
	Diffraction	○		96
	Vignetting	○		96
	Color Shading	○		96

### / SHOOT(4)

Menu Item	Second-level Menu Item	C	S	Page
Focus	Focus Mode	○	○	51
	Focus Area	○	○	53
	AF + MF		○	55
	Pre-AF	-	○	56
	Constant AF	○	-	56
	Face / Eye Detection AF	○		56
	Focus Limiter	○		57
	AF during Image Magnification	○		58
	AF Magnification	○		57
	Prioritize Focus / Release	-	○	59



Menu Item	Second-level Menu Item	C	S	Page
Focus	MF Magnification		○	59
	MF Display	○	○	60
	Focus Peaking		○	61
	Quick Focus Frame Shift		○	61
Stabilization	Lens Optical Stabilization		○	66
	Electronic Stabilization	○	○	66
Lens Function Settings	Focus Mode	○	○	51
	Focus Limiter		○	57
	Optical Stabilization		○	66
	AFL Button Settings		○	112
Flash	Flash Exposure Compensation	-	○	111
	Red-eye	-	○	110
	Rear Curtain Sync.	-	○	110
	Slow Sync.	-	○	110
	AF Assist Light	-	○	111

## / SHOOT(5)

Menu Item	Second-level Menu Item	C	S	Page
Shutter blackout	-	-	○	113
Quick Preview	-	-	○	42
Outer Frame	-	-	○	72
Frame Guide	-	○	-	113
Director's Viewfinder	-	○	-	81
Preview Exposure in M Mode	-	-	○	48
Brightness Level Monitor	-	○	○	49
Zebra Pattern	-		○	49

## / SHOOT(6)

Menu Item	Second-level Menu Item	C	S	Page
Dial Settings	Dial Functions		○	115
	Dial Rotation		○	116
	Disable Dial Functions	○	-	116

Menu Item	Second-level Menu Item	C	S	Page
Custom Buttons Functions	-		○	116
Shutter Button Settings	Shutter Button Functions	○	-	117
	Half-pressed AEL	-	○	117
	Half-pressed AF-ON		○	117
REC Button Settings	-	-	○	117

## ▶ PLAY(1)

Menu Item	Second-level Menu Item	C	S	Page
Filtering Options for Display	-		○	127
Lock	-		○	127
Mark	-		○	129
Rotate	-	-	○	131
Delete	-		○	124
Slideshow	-		○	132

## ▶ PLAY(2)

Menu Item	Second-level Menu Item	C	S	Page
DNG Development	-		○	133
Cinemagraph	-		○	134
Exposure Warning	-		○	138
Image Rotation	-		○	139
AEL Button Settings	-		○	139

## 🔧 SYSTEM(1)

Menu Item	Second-level Menu Item	C	S	Page
Memory Media Format	-		○	42,140
Memory Media	-		○	140
File Name / Number	-	○	○	140
Copyright Information	-		○	142
Time Code	-	○	-	143

## SYSTEM(2)

Menu Item	Second-level Menu Item	C	S	Page
Shooting Style	-	<input type="radio"/>	-	43
Custom Mode Setting	-		<input type="radio"/>	105
Custom QS	-	<input type="radio"/>	<input type="radio"/>	37
 Mode Settings	-	<input type="radio"/>	<input type="radio"/>	146
Operation in LOCK Mode	-		<input type="radio"/>	109
Touch Operation	-		<input type="radio"/>	27,148

## SYSTEM(3)

Menu Item	Second-level Menu Item	C	S	Page
Electronic Sounds	-		<input type="radio"/>	150
Adjust Electronic Level	-		<input type="radio"/>	150
Pixel Refresh	-		<input type="radio"/>	150
LCD Settings	-		<input type="radio"/>	150
Power Save	LCD Off		<input type="radio"/>	151
	Auto Power Off		<input type="radio"/>	151
	ECO Mode		<input type="radio"/>	151

## SYSTEM(4)

Menu Item	Second-level Menu Item	C	S	Page
HDMI Output	-	<input type="radio"/>	<input type="radio"/>	151
USB Mode	-		<input type="radio"/>	153
Cable Release Settings	-	<input type="radio"/>	<input type="radio"/>	153
EVF Settings	-		<input type="radio"/>	154

## SYSTEM(5)

Menu Item	Second-level Menu Item	C	S	Page
Date / Time / Area	-		<input type="radio"/>	25
Language / 言語	-		<input type="radio"/>	24
Information	-		<input type="radio"/>	154
Firmware Update	-		<input type="radio"/>	155
Save / Load Settings 	-		<input type="radio"/>	106
Reset Settings	-		<input type="radio"/>	155

# QUICK SET MENU

The following most frequently used menu items can be easily set by pressing the **QS** button.

## In STILL mode

AE Metering Mode (P.85)		Drive Mode (P.63)
ISO Sensitivity (P.67)		White Balance (P.87)
Image Quality (P.70)		Fill Light (P.95)
Image Size (P.71)		Aspect Ratio (P.72)

Option list display of the selected items

## In CINE mode (CINE style)

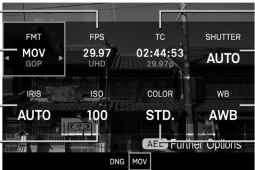
Frame Rate (P.74)		Time Code (P.143)
Format (P.73)		Shutter Angle (P.47)(P.48)
Aperture (P.46)(P.48)		White Balance (P.87)
ISO Sensitivity (P.67)		Color Mode (P.91)

## In CINE mode (STILL-like style)

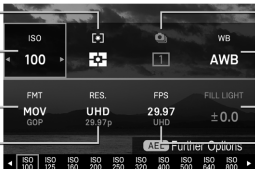
AE Metering Mode (P.85)		Drive Mode (P.63)
ISO Sensitivity (P.67)		White Balance (P.87)
Format (P.73)		Fill Light (P.95)
Resolution (P.74)		Frame Rate (P.74)

## For example, to change the image quality to DNG

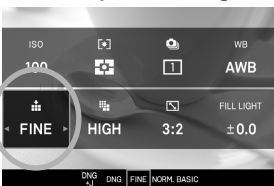

1

Press the **QS** button to display the Quick Set Menu.

2

Press the **◀▶** buttons to select the item related to image quality (**📷**).

3

Rotate the Front Dial or the Rear Dial to display **[DNG]**.

4

Press the **OK** button or half-press the shutter button to return to the shooting mode.

### TIP

It may be possible to make more detailed settings depending on items or options. In such a case, "**AEL Further Options**" is displayed. Press the **AEL** button to configure the desired settings as needed.

### CAUTION

- Items that you cannot set are grayed out, and the options cannot be changed by rotating the dials.

## You can change the items to be allocated to the QS menu. (CINE/STILL)



**[SYSTEM] → [Custom QS]**

1

Press the **◀▶** buttons on the **[Custom QS]** screen to select the position you want to reallocate, and press the **OK** button to apply the setting.

2

From the list at the bottom of the screen, select the items you want to allocate by pressing the **◀▶** buttons, and press the **OK** button to confirm your selection.

3

When you have finished setting the allocation, press the **MENU** button to close the **[Custom QS]** screen.

- The items that can be allocated to the QS menu are:

\* **C** = CINE mode, **S** = STILL mode

Menu Item	C	S	Menu Item	C	S
Shooting Mode	○	○	Color Mode	○	○
Shutter Speed / Shutter Angle *1	○	○	Color Effect Amount	○	○
Aperture	○	○	Tone Control	○	○
Exposure Compensation	○	○	Fill Light	-	○
ISO Sensitivity	○	○	Color Shading Correction	○	○
AE Metering Mode	○	○	Focus Mode	○	○
Drive Mode	○*3	○	Focus Area	○	○
Exposure BKT Amount	○*3	○	Pre-AF / Constant AF *2	○	○
Focus BKT Amount	○*3	○	Face/Eye Detection AF	○	○
White Balance BKT Amount	○*3	○	Focus Limiter	○	○
Color Mode BKT	○*3	○	Focus Peaking	○	○
Fill Light BKT Amount	○*3	○	Optical Stabilization	○	○
HDR	○	○	Electronic Stabilization	○	○
DC Crop Mode	○	○	Flash Exposure Compensation	○*3	○
Image Quality / Format *2	○	○	Red-eye	○*3	○
Image Size / Resolution *2	○	○	Rear Curtain Sync.	○*3	○
Aspect Ratio / Frame Rate *2	○	○	Slow Sync.	○*3	○
Audio Record	○	-	Director's Viewfinder	○	-
Audio Gain Adjustment	○	-	Time Code	○	-
White Balance	○	○	LOCK	○	○
WB Color Temperature	○	○	LCD Brightness	○	○
			Headphone Volume	○	-

\*1 Changes depending on the setting of the shutter mode (see page 45).

\*2 Changes depending on the setting of the CINE/STILL mode (see page 28).

\*3 This is a function for still images. When the Shooting Style is set to [STILL-like], it can only be allocated, even in CINE mode.

# CHANGING THE DISPLAY MODE

LCD Monitor Display can be changed by pressing the  button.

## In STILL mode

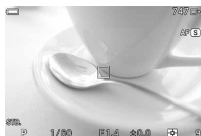

Custom 1

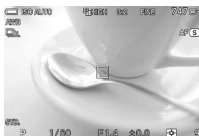

Custom 2

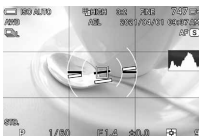

Custom 3

## In CINE mode (CINE style)



Custom 1



Custom 2



Custom 3

## In CINE mode (STILL-like style)



Custom 1



Custom 2



Custom 3

- Refer to MONITOR DISPLAY DURING SHOOTING on page 16 for the meaning of each icon.
- You can customize the information you want to view (refer to page 146).
- The size of icons and text can be changed (refer to page 146).

## (PLAYBACK MODE)



Display Icons  
(Display date and  
time) (P.118)



Display Icons  
(Display Image  
Info\*1) (P.118)

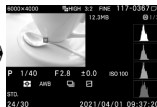

1/3 Display Image  
Info Screen (Display  
Image Info\*1) (P.120)



Hide Icons



2/3 Display Image  
Info Screen (Lens  
Optics Compensation)  
(P.120)



3/3 Display Image  
Info Screen  
(Copyright Information  
screen) (P.120)

- \*1 When playing back cinemagraphs, the exposure compensation value and playback speed during editing are displayed.



## TO INSERT THE CARD

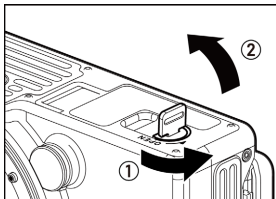

**1**

Make sure that the power switch is set to OFF. Rotate the battery/SD card cover latch to open the cover.

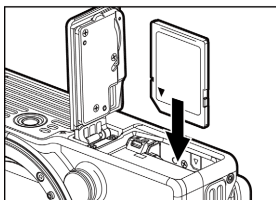

**2**

Insert the card as per the instructions.

- Insert the card until it clicks.

**3**

Close the battery compartment cover and lock the cover by turning the battery/SD card cover latch.

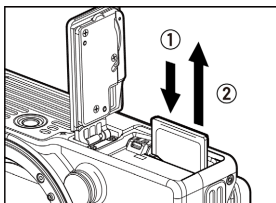

## TO REMOVE THE CARD

Push the card in until it clicks and then pull it out straight.

## WARNING!!

- While the Busy Lamp is on or flashing, do not take out the battery or the card. By doing so, it may result in data loss. This could also cause damage to the camera and/or memory card.

## TIP

- If the camera is turned off while the Busy Lamp is on or flashing, the camera will remain on until it has finished accessing the card.

## FORMATTING THE CARD

Be sure to format the cards in the camera before use. If your camera is unable to take pictures because of a card error, format the card.

[ **SYSTEM**] → [**Memory Media Format**] → [**SD Card**]

In [**SD Card Format**] screen, press the **<>** buttons, select [**Yes**], and then press the **OK** button.

To cancel, select [**No**] and press the **OK** button.

## WARNING

- Formatting erases all files, including locked files.

## HOW TO PRESS THE SHUTTER BUTTON

When you lightly press the shutter button down until it stops, the camera is placed in the shooting mode, and the focusing mechanism is activated (half-press). When you press the shutter button further, the shutter is released (hold-down).

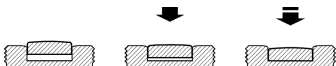

## QUICK PREVIEW

You can change the duration of the Quick Preview images that are displayed after they are captured.

[ **SHOOT**] → [**Quick Preview**]

<b>Off</b>	No preview is displayed.	
<b>2 sec. (default)</b>	<b>5 sec.</b>	<b>10 sec.</b>

## CAUTION

- It will not be possible to zoom in to the preview image, or change to another image while the Quick Preview is up.

# DOING THE SHOOTING

## TAKING A PICTURE

The general procedure to follow to take a picture is as follows.

**Set the CINE/STILL switch to [STILL].**

**Configure image settings such as the image quality and image size. (P.70)**

**Set the ISO sensitivity. (P.67)**

**Determine the exposure. (P.45)**

**Focus the camera. (P.51)**

**Hold-down the shutter button to take a picture.**

- For information about other settings, refer to the appropriate pages.

## SHOOTING A MOVIE

The general procedure to shoot a movie is as follows.

**Set the CINE/STILL switch to "CINE".**

**Determine the shooting style.**

You can select the setting method and the monitor display for shooting to suit the style of camera you are used to.

[ SYSTEM] → [Shooting Style]

<b>CINE</b>	Provides the setting method and the monitor display based on the cinema camera style.
<b>STILL-like</b>	Provides the setting method and the monitor display based on the still camera style.

**Configure movie record settings such as the record format, resolution, and frame rate. (P.73)**

**Set the ISO sensitivity. (P.67)**

**Determine the exposure. (P.45)**

**Focus the camera. (P.51)**

**Press the shutter button or REC button to start shooting.**

During movie shooting...

<b>CINE</b>	REC lamp: Lights, Recording indicator: ● <b>REC</b>
<b>STILL-like</b>	REC lamp: Lights, Recording indicator: ● (red)

Press the **REC** button again to stop shooting.

When movie shooting stops...

<b>CINE</b>	REC lamp: Turned off, Recording indicator: ● <b>STBY</b>
<b>STILL-like</b>	REC lamp: Turned off, Recording indicator: Turned off

- For information about other settings, refer to the appropriate pages.

## CAUTION

- The REC button does not activate AF mode. When Constant AF (P.56) is set to [Off], half-press the shutter button to activate AF mode.
- The maximum length of time a movie can be recorded using a single shooting operation is two hours even if there is sufficient free space on the media for a longer period.

## TIP

**You can shoot a movie using the REC button even in STILL mode.**

- Set the REC Button Settings to [REC].

[ SHOOT] → [REC Button Settings] → [REC]

- A movie is recorded based on the setting described in [Record Settings] (P.73) of the Set-up menu.

**You can take a picture using the release button even when in CINE mode.**

- Set the Shutter Button Settings to [Shutter].

[ SHOOT] → [Shutter Button Settings] → [Shutter]

- In terms of image quality, still images are recorded in the JPEG (FINE) format.
- The image sizes of still images vary depending on the resolution setting in [Record Settings] (P.73).

<b>Resolution</b>	<b>UHD</b>	3840x2160
	<b>FHD</b>	1920x1080

## SELECTING THE EXPOSURE MODE

---

The features and the operation methods of the four different exposure modes of the camera are explained below.

<b>P</b>	<b>Program AE</b>	<b>S</b>	<b>Shutter Speed Priority AE*</b>
<b>A</b>	<b>Aperture Priority AE</b>	<b>M</b>	<b>Manual Exposure</b>

\*If [Shutter Mode] in [ SHOOT] is set to [Angle], [Shutter Angle Priority AE] is displayed when the camera is in CINE style.

### CAUTION

- The explanations in this section are based on the assumption that [Dial Settings] in [ / SHOOT] menu is in its default setting. If the actual operating procedure differs from the description in this section, refer to [DIAL SETTINGS] on page 115.

## SELECTING THE EXPOSURE MODE

---

### 1

Press the **MODE** button.

### 2

Select the desired exposure mode by using the Front and Rear Dials, or by pressing the **<>** buttons.

### 3

Press the **OK** button or half-press the shutter button to apply the setting.

- The exposure mode can also be set by selecting [ / SHOOT] → [Exposure Settings] → [Shooting Mode].

## P PROGRAM AE

---

Use this mode for casual shooting. In the Program AE mode, the camera automatically selects an appropriate combination of shutter speed and aperture values based on the brightness of the subject.

### CAUTION

- If the  mark is shown, it may cause the camera to shake because the shutter speed reduces. Increase the ISO sensitivity (see page 67) or use a tripod.
- If the subject is too bright or dark, both shutter speed and aperture value indicators flash. Decrease the ISO sensitivity (see page 67).

### PROGRAM SHIFT \*P

#### (STILL)

You can change the combination of shutter speed and aperture value selected by the camera while retaining the same exposure level. Adjust the shutter speed and aperture value using the Front Dial.

## A APERTURE PRIORITY AE

---

Set the desired aperture. In Aperture Priority AE mode, the camera determines the appropriate shutter speed based on the brightness of the subject.

- Rotate the Front dial to set the desired aperture.

### CAUTION

- If the  mark is shown, it may cause the camera to shake because the shutter speed reduces. Increase the ISO sensitivity (see page 67) or use a tripod.
- If the subject is too bright or dark, the shutter speed indicator flashes. Adjust the aperture until it stops flashing.

### In CINE mode (CINE style)

To set the aperture, open the Quick Set menu or select [ SHOOT] → [Exposure Settings].

To switch to P Mode, in the Quick Set menu, press the  button while selecting the aperture, and in the [ SHOOT] menu, set the aperture value to [Auto].

## S SHUTTER SPEED (SHUTTER ANGLE) PRIORITY AE

---

Set the desired shutter speed (shutter angle). The camera automatically determines the aperture value based on the brightness of the subject.

- Set the desired shutter speed by rotating the Front Dial.

### CAUTION

- If the subject is too bright or dark, the aperture value indicator flashes. Adjust the shutter speed until it stops flashing.

### In CINE mode (CINE style)

- To set the shutter angle (speed), open the Quick Set menu or select [SHOOT] → [Exposure Settings].
- To switch to P Mode, in the Quick Set menu, press the [ ] button while selecting the shutter angle, and in the [SHOOT] menu, set the shutter angle (speed) to [Auto].

## M MANUAL EXPOSURE

---

Set both the shutter speed (angle) and aperture value.

Set the aperture value using the Front Dial. Then, set the shutter angle (speed) using the Rear Dial so that the numeric value of the exposure meter is set to "0.0".

- The exposure meter can display an exposure error of up to  $\pm 5$  stops from the correct exposure in 1/ 3 steps. If the exposure error is more than three stops, the exposure meter will flash.

### When the ISO Sensitivity (P.67) is set to [ISO Auto]:



Images are taken using Auto Exposure in which the camera automatically sets the ISO sensitivity according to the brightness of the subject.

### CAUTION

- If the subject is too bright or too dark, the ISO indicator flashes. Adjust the shutter speed (angle) or aperture until the indicator stops flashing.

### In CINE mode (CINE style)

- To set the shutter angle (speed) and aperture, open the Quick Set menu or select [SHOOT] → [Exposure Settings].

- In the Quick Set menu, to switch to **S** Mode, press the  button while selecting the aperture. To switch to **A** mode, press the  button while selecting the shutter angle.
- In the  **SHOOT** menu, to switch to **S** mode, set the aperture value to **[Auto]**. To switch to **A** mode, set the shutter angle (speed) to **[Auto]**.

## TIP

### WHEN YOU ARE USING AN L-MOUNT LENS WITH AN APERTURE RING:

In Aperture Priority AE or Manual Exposure mode, you can set the aperture value using the aperture ring of the lens. If you want to select an aperture value using the camera menu or dial, set the aperture ring to position A.

### ABOUT THE SHUTTER ANGLE (CINE/CINE STYLE)

For the cinema camera, the shutter angle (angle) is generally used as the unit of exposure time in the shutter. For example, "360°" means that an exposure time of 100% is applied for each frame, and "180°" means that an exposure time of 50% is applied for each frame.

### DIAL OPERATION IN CINE MODE (CINE STYLE)

In general use, an exposure operation carried out by dialing is prohibited in CINE mode (CINE style), however, it can be permitted as needed.

 **SHOOT** → **[Dial Settings]** → **[Disable Dial Functions]** → **[Off]**

### LCD DISPLAY MONITOR IN M MODE

#### (STILL)

When the exposure mode is set to M, the actual exposure is applied to the screen. If it is difficult to confirm the focus or composition, you can switch the screen brightness to the desired mode.

 **SHOOT** → **[Preview Exposure in M Mode]**

<b>Off</b>	Brightness of the LCD Display is automatically adjusted for better visibility.
<b>On (Default)</b>	The selected exposure value is reflected in the LCD Display.



- When ELECTRONIC FLASH EF-630 (FOR SIGMA) is used with the camera, the brightness of the LCD Display is automatically adjusted for better visibility even when the function is [On].

## BRIGHTNESS LEVEL MONITOR

---

### (CINE/STILL)

The brightness level can be selected from two types of brightness level views as a means to judge the exposure when shooting.

[ /  SHOOT] → [Brightness Level Monitor]

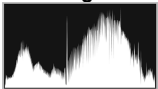
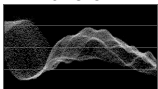
<p><b>Histogram</b></p> 	<p>For details on the histogram, refer to page 123.</p>
<p><b>Waveform</b></p> 	<p>The horizontal axis indicates the horizontal position of the screen, and the vertical axis indicates the brightness level (bottom: 0, top: 255). Unlike the histogram, you can easily grasp the status of the brightness value at a given location.</p>



- Whether to display the brightness level monitor can be selected from [Brightness Level Monitor] in Display Mode Settings (P.146). You can also assign this function to a custom button (P.116).
- In CINE mode (CINE style), both the histogram and waveform can be selected from two sizes (Standard and Wide).

## ZEBRA PATTERN

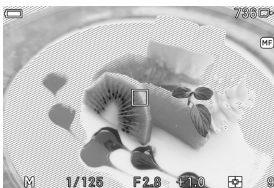
---



Parts that may be overexposed are shown in zebra patterns.

[ /  SHOOT] → [Zebra Pattern] → [Zebra Display]

<b>Highlight</b>	Displays the higher brightness value range in zebra patterns using the arbitrary brightness value as a standard.
<b>Exposure Level</b>	Displays the arbitrary percentage range in zebra patterns using the arbitrary brightness value as a standard.

#### HIGHLIGHT DISPLAY SETTING OPTIONS:

<b>Highlight Level</b>	<b>70 to 100%</b> (Brightness value: Approx.178 to 255)
<b>Color</b>	<b>White, Black, Red, Yellow, Blue, Green</b>

#### EXPOSURE LEVEL DISPLAY SETTING OPTIONS:

<b>Exposure Level</b>	<b>0 to 100%</b> (Brightness value: Approx.0 to 255)
<b>Range</b>	<b>±5 to 30%</b>
<b>Color</b>	<b>White, Black, Red, Yellow, Blue, Green</b>

- Whether to display the Zebra Pattern can be selected from [**Zebra Pattern**] in Display Mode Settings (P.146). You can also assign this function to a custom button (P.116).

## BULB SETTING

---

### (STILL)

The shutter remains open when the shutter button is pressed all the way down.

#### 1

Set the Exposure Mode to the **M** position.

#### 2

Rotate the Rear dial until **BULB** is displayed.

#### 3

Rotate the Front dial to select the desired aperture value.

#### 4

Depress the shutter button fully to take the picture.

### CAUTION

- It is not possible to use Bulb photography for more than 300 seconds. The shutter will automatically close about 300 seconds after the shutter button was pressed.
- A long exposure may increase noise.
- It cannot be set to BULB during ISO Auto.

# FOCUSING

## HOW TO USE AUTOFOCUS

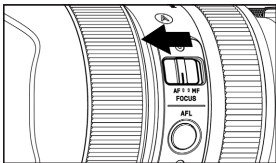

1

Set the focus mode selector switch (if present on the lens) to AF mode.



2

Set the camera's focus mode to **AF S** (P.51). (Set to **AF** in CINE mode.)



3

Place the photograph subject in the multi-point distance measurement area frame, and half-press the shutter button.

- The focus frame at the focused position is displayed in green, the focus indicator lights up, and the focus sound beeps. (No focus sound beeps in CINE mode.)

- If the subject is out of focus, the multi-point distance measurement area frame flash.

### CAUTION

- In CINE mode (CINE style), the multi-point distance measurement area frame and focus frame are displayed only when the shutter button is being half-pressed.

## FOCUS MODE SETTING

The focus mode can be selected depending on the subject.

Press the **FOCUS** button, and select the desired focus mode using the Front/Rear dial or the **<>** buttons.

You can also select [ / SHOOT] → [Focus] → [Focus Mode] to set Focus mode.

You can also select [ / SHOOT] → [Lens Function Settings] → [Focus Mode] to set Focus mode.



After the setting is completed, press the button or half-press the shutter button to apply the setting.



<p><b>AF </b> <b>Single AF</b>  (Default)</p>	<p><b>(STILL)</b> Available for a still subject. When the subject comes into focus, the focus point is fixed while the shutter button is being half-pressed. You can change the composition of the shoot while the focus point remains fixed (Focus Lock shooting*).</p> <ul style="list-style-type: none"><li>● The exposure is locked at the value when the shutter button is half-pressed.</li><li>● When Continuous Drive Mode is selected, continuous shooting is conducted at the focus position of the first frame.</li></ul>
<p><b>AF </b> <b>Continuous AF</b></p>	<p><b>(STILL)</b> Available for a moving subject. While the shutter button is half-pressed, the autofocus continues to function. When it comes into focus, the Focus Indicator opens, but the focus is not locked.</p> <ul style="list-style-type: none"><li>● The exposure is set when the shutter button is released.</li><li>● When Continuous Drive Mode is selected, auto focus drive and shooting are continued repeatedly.</li><li>● The focusing accuracy may reduce depending on the conditions of the subject.</li><li>● The electronic beeping sound does not sound.</li><li>● The Image Magnification function is not available.</li></ul>
<p><b></b> <b>Manual Focus</b></p>	<p>Manually focus the camera. Turn the focusing ring on the lens until you get a clear sharp image.</p>

\* You can also perform Focus Lock shooting using the **AEL** button that is assigned to the focus lock function (page 86).



## FOCUS FRAME SETTING

You can change the focus frame size or position as well as the operation method.

Press the  button, and select the desired option using the Front/Rear dial or the   buttons.

You can also select [ /  SHOOT] → [Focus] → [Focus Area] to set the target.

After the setting is completed, press the  button or half-press the shutter button to apply the setting.

 AUTO	<b>Multi Auto Focus Points</b> (Default)		
	<b>Single</b> (1-point selection)		<b>Tracking</b>



## MULTI AUTO FOCUS POINTS

Uses up to 49 focus frames for focusing. This function is available when the subject is in the center.



The range of the distance measurement area can be changed by pressing the **AEL** button and turning the Front/Rear dial (the size of the multi-point distance measurement area frame is changed).



When the range of the distance measurement area is narrowed, you can use the   buttons to move the position of the multi-point distance measurement area frame.

- You can also perform a touch operation (tap or drag) to move the position of the multi-point distance measurement area frame.
- Press the **MODE** button to return the position of the multi-point measurement area frame to the center.

## SINGLE (1-POINT SELECTION)

Focus with the focus frame at the desired position. This function is available when the subject position is determined.

### 49 points select mode



### Free move mode



Focusing point moving area

- Each time the **AEL** button is pressed, the mode switches between [49 points select mode] and [Free move mode].
- When [49 points select mode] is selected, choose the desired focus frame by pressing the **◀▶** buttons.
- When [Free move mode] is selected, move the focusing point as you like by pressing the **◀▶** buttons (focusing points can be moved inside the focusing point moving area).
- To change the size of the Focus Frame (L, M, S), rotate the Front or the Rear Dial.
- You can move the focus frame by tapping or dragging it.
- You can use the **◀▶** button to move the focus frame during image magnification.
- Press the **MODE** button to return the focus frame to the center.

## TRACKING



### (STILL)

The camera automatically tracks focus-locked subject.

- Tracking can be set in AF-C mode only.



Adjust the subject to the focus frame, and half-press the shutter button.

## 2

When the camera has focused on the subject, the frame color changes to green. If the subject has moved, the focusing point to which it has moved appears.

- If tracking is interrupted, the focus frame returns to the initial position.

### CAUTION

- Tracking may not operate properly under certain conditions such as when:
  - the movement of the subject is too rapid
  - the subject is too small or too large
  - the brightness of the scene changes
  - the scene is dark.

## FOCUSING USING MANUAL FOCUS

### 1

Set the focus mode selector switch (if one is on the lens) to MF.

Set the camera's Focus mode to MF (Manual Focus) if the lens does not have a Focus mode selector switch (see P.51).

### 2

Turn the focusing ring on the lens to obtain a clear, sharp image.

## OTHER FOCUS SETTINGS

### AF+MF

You can manually make fine focus adjustments after focusing with the auto focus function.

  **SHOOT**] → [**Focus**] → [**AF+MF**] → [**On**]

Half-press the shutter button. After it focuses, turn the focus ring to adjust the focus while half-pressing the shutter button.

### CAUTION

If a lens with manual fine-adjustment enabled is attached via the mount converter MC-21, it is always possible to make fine adjustments even if the camera is set to [**Off**].

## PRE-AF

---

### (STILL)

AF mode is activated before the shutter button is half-pressed.

[ SHOOT] → [Focus] → [Pre-AF] → [On]

## CONSTANT AF

---

### (CINE)

AF mode is activated before movie recording, and it continues to operate even when a movie is being recorded.

[ SHOOT] → [Focus] → [Constant AF] → [On]

## FACE / EYE DETECTION AF

---

Preferentially focuses the face or eye of a person.

Press the button and then press the **AEL** button. Each time you press the button, you can switch between Face Only and Face/Eye Detection AF.

Otherwise, to set this mode, select [ / SHOOT] → [Focus] → [Face / Eye Detection AF].

	<b>Off (Default)</b>	Sets to the normal AF mode.
	<b>Face Only</b>	When a face is detected, it is focused on preferentially.
	<b>Face / Eye Auto</b>	When a face is detected, it is focused on preferentially, and when an eye is detected, it is focused on.



When a face and an eye are detected, the orange detection frame is displayed.

When the detected face and eye are focused after the shutter button is half-pressed, the detection frame changes to green.



- The mode is changed to "Evaluative" that focuses on the detected face.
- If multiple people's faces are detected, the detection frame is displayed for the face that appears to be the nearest.

## CAUTION

- [Face / Eye Detection AF] is not available in MF mode.
- The face/eye detection may fail in the following cases:
  - A part of the face is covered by sunglasses, a hat, bangs, etc.
  - The scene is dark or backlit.
  - The subject is out of focus.
  - The subject is moving quickly.
- If face detection fails, the face is focused on using the selected focus frame.

## FOCUS LIMITER

---

Limits the focus operating range to accelerate the AF speed.

[ / SHOOT] → [Focus] → [Focus Limiter]

or [ / SHOOT] → [Lens Function Settings] → [Focus Limiter]

Off (Default)		Does not limit the operating range.
On	Near Side	The focus operates only on the near side from almost at the center.
	Far Side	The focus operates only on the far side from almost at the center.



If [Near Side] is selected, the icon is displayed. If [Far Side] is selected, the icon is displayed.

### CAUTION

- This setting is only available for compatible lenses. For details, please refer to the lens manual.

## AF MAGNIFICATION

---

Specify the magnification method in AF mode.

[ / SHOOT] → [Focus] → [AF Magnification]

<b>Image Magnification</b>	Select the image magnification range.
<b>Auto Magnification</b>	Sets whether or not to automatically magnify an image when focusing.
<b>Duration of Auto Magnification</b>	Specify the magnification period.

### Image Magnification

<b>Full Screen</b>	Magnifies an image on the full screen.
<b>PIP</b>	Magnifies an image in the range of 25% in the center of the screen.

### Auto Magnification

<b>Off</b>	Does not perform auto magnification.
<b>On</b>	Performs auto magnification.

### Duration of Auto Magnification

<b>1 sec.</b>	<b>2 sec.</b>	<b>5 sec.</b>
---------------	---------------	---------------

- In AF mode, an image is magnified, centering around the focus frame that was focused.
- During image magnification, the magnification (4x/8x) can be changed using the Front/Rear dial.

## AF DURING IMAGE MAGNIFICATION



AF shooting is possible during image magnification. You can focus on a fine part.

[ / SHOOT] → [Focus] → [AF during Image Magnification] → [On]

Setting it to [On] displays the "+" mark in the center of the magnified image.

Press the **OK** button to magnify the image, adjust the subject to the "+" mark, and half-press the shutter button. When the subject is focused, the "+" mark changes to green. Then, release the shutter.

## TIP



- The shutter is released with the image magnified, so determine the composition and focus frame position before shooting.
- You can use the  button to move the focus frame during image magnification.
- Press the **MODE** button to return the focus frame to the center.

## PRIORITIZE FOCUS / RELEASE

---

### (STILL)

You can change the operation that starts when the shutter button is held down in each AF mode.

To set this option, select [ **SHOOT**] → [**Focus**] → [**Prioritize Focus / Release**] → [**AF**  **Priority**] or [**AF**  **Priority**].

<b>Release</b>	Releases the shutter even if the subject is out of focus.
<b>Focus</b> (Default)	Does not release the shutter until the subject is focused.

- **AF**  In, when Drive mode is set to [**Continuous**], continuous shooting is carried out at the first frame's focus position even if either setting is selected.

## MF MAGNIFICATION

---

Specify the magnification method in MF mode.

[ /  **SHOOT**] → [**Focus**] → [**MF Magnification**]

<b>Image Magnification</b>	Select the image magnification range.
<b>Auto Magnification</b>	Sets whether or not to automatically magnify an image when the focus ring is turned.
<b>Duration of Auto Magnification</b>	Specify the magnification period.

### Image Magnification

<b>Full Screen</b>	Magnifies an image on the full screen.
<b>PIP</b>	Magnifies an image in the range of 25% in the center of the screen.

## Auto Magnification

<b>Off</b>	Does not perform auto magnification.
<b>On</b>	Performs auto magnification.

## Duration of Auto Magnification

<b>1 sec.</b>	<b>2 sec.</b>	<b>5 sec.</b>
---------------	---------------	---------------

- An image is magnified, centering around the displayed focus frame.
- During image magnification, the magnification (4x/8x) can be changed using the Front/Rear dial.

## IMAGE MAGNIFICATION USING THE OK BUTTON

---

Pressing the **OK** button enables image magnification. The Image Magnification function is available when you want to pre-check the focus point, when [**Auto Magnification**] is set to [**Off**], or when the lens does not support Auto Magnification.

- To return to the normal display, press the **OK** button again.
- In MF mode, if you half-press the shutter button; Image Magnification is released temporarily.
- The Image Magnification function can be assigned to the **AEL** button.
- Also, you can double-tap the touch panel to enable Image Magnification in the same way as when using the **OK** button.



## MF DISPLAY

---

### (CINE/STILL)

This function displays the scale bar that is useful for focusing in MF mode.

[ /  SHOOT] → [Focus] → [MF Display]

<b>Off</b>	Does not display the scale bar.
<b>Scale Bar</b> 	Displays the scale bar on which the far side is on the left and the near side is on the right.
<b>Scale Bar</b> 	Displays the scale bar on which the near side is on the left and the far side is on the right.
<b>Shooting Distance</b>	Select the unit of shooting distance. <b>M</b> (meter), <b>FEET</b> (feet)

## CAUTION

- This setting is only available for compatible lenses.

## FOCUS PEAKING

---

Emphasizes the outline of the focused part on the subject in the display. This function is useful for focusing. For peaking, you can select easy-to-see colors depending on the subject.

[ /  SHOOT] → [Focus] → [Focus Peaking]

Off (Default) OFF	White WH	Black BK	Red R	Yellow YE
----------------------	-------------	-------------	----------	--------------

## CAUTION

- [Focus Peaking] cannot be used with [Zebra Pattern] (P.49). If both are set to [On], [Zebra Pattern] is given priority.

## QUICK FOCUS FRAME SHIFT

---

You can use the  button to directly move the focus frame (the multi-point measurement area frame when the camera is in Multi Auto Focus Points mode).

- This function must be assigned to the  button. Refer to [CUSTOM BUTTONS FUNCTIONS] (P.116).

## DEPTH OF FIELD PREVIEW

---

### (STILL)

You can check the depth of field (the area in an image that appears acceptably sharp) by narrowing down to the actual f-number before shooting.

- This function must be assigned to a custom button. Assign [Depth of Field Preview] to your desired custom button (P.116).

- The Depth of Field Preview is activated while the button is pressed and held down.
- The button to which the Depth of Field Preview is assigned will not function in CINE mode.

## TOUCH AF / TOUCH SHUTTER

---

You can activate AF mode or take pictures by tapping the touch panel.

To set Touch AF/Touch Shutter, select [ SYSTEM] → [Touch Operation] → [On] → [Tap].

- Both [Touch AF] and [Touch Shutter] are activated within the moving range of the focus frame.

### Touch AF

Autofocus is activated at the point you tap.

- When the focus frame is set to [Single], the focus frame is maintained at the point you tap.
- When the focus frame is set to [Multi Auto Focus Points] and [Tracking], the focus frame returns to the previous state after focusing.
- When [Face / Eye Detection AF] is selected, face / eye detection is restarted after focusing.
- When Manual Focus is selected, the focus frame moves to the point you tap. However, Autofocus is not activated.

### Touch Shutter

#### (STILL)

Autofocus is activated to take a picture at the point you tap.

- Touch Shutter is not available in CINE mode.
- The movement of the focus frame after a picture is taken is almost the same as when you use [Touch AF].
- When Manual Focus is selected, pictures are taken without auto focusing. After pictures are taken, the focus frame moves to the point you tap.

# DRIVE MODE

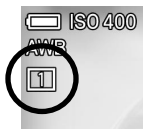

## (STILL)

Select the operation at the time the shutter is released, for example, self-timer or continuous shooting.

To set the operation, open the Quick Set menu or select [SHOOT] → [Drive Mode].

	<b>Single Capture (Default)</b>		<b>Self Timer 2 sec.</b>
	<b>Continuous (High Speed)</b>		<b>Self Timer 10 sec.</b>
	<b>Continuous (Medium Speed)</b>		<b>Interval Timer</b>
	<b>Continuous (Low Speed)</b>		

## SINGLE CAPTURE

When you press the shutter button, only one image is captured.

## CONTINUOUS

When you keep the shutter button fully depressed, the camera continuously captures images.









The number in the bottom right of the LCD monitor indicates how much buffer is left. It is the maximum number of frames for continuous shooting. (If the maximum number of frames for continuous shooting exceeds nine frames, the display will not change from 9) When the number becomes "0", the shutter cannot be released.

## CAUTION

- The following functions or settings cannot be used in combination.

HDR, Focus BKT, Fill Light BKT, Electronic Stabilization, Fill Light, ISO sensitivity settings added with the [Composite Low ISO Expansion], Flash photography
--

- The maximum number of frames and speed of continuous shooting are as follows: (The upper rows show the maximum number of frames, the lower rows show the maximum shooting speed in continuous mode (frames per second)).

	Image Size		
	 HIGH	 MED	 LOW
 <b>Continuous (High Speed)</b>	12	12	24
	18		
 <b>Continuous (Medium Speed)</b>	12	12	24
	5		
 <b>Continuous (Low Speed)</b>	12	12	24
	3		

## SELF TIMER

---

### Self Timer 2 sec

The shutter will be released 2 seconds after the shutter button is fully depressed.

### Self Timer 10 sec

The shutter will be released 10 seconds after the shutter button is fully depressed.

After composing the picture, press the shutter button “half-way” and adjust the focusing. Then, press the shutter button the rest of the way and the self-timer will activate. During the self-timer operation you will hear an electronic beeping sound. The beeping sound will be much faster during the last two seconds, before the shutter is released.



- When [ **SYSTEM**] → [**Electronic Sounds**] → [**Timer Volume**] menu is set to [0], the electronic sound will not beep even if the self-timer is operated.
- If you want to cancel the self-timer operation, please turn off the camera.



## INTERVAL TIMER

---

It is possible to take pictures automatically at selected intervals.



Select [**Interval timer**] and press the  button to display the Interval Timer setting screen. (When the  button is pressed after selecting [**Interval timer**], the picture is taken with previously used settings.)

To set from the Quick Set Menu, select [], and press the **AEL** button to display the Interval Timer setting screen. (When the  button is pressed or the shutter button is pressed halfway after selecting [], the picture is taken with previously used settings.)



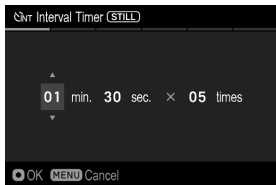

## 2

Set the desired interval and number of exposures by using the  $\left\langle \right\rangle$  buttons.

(Interval can be set from 1 seconds to 60 minutes. The number of exposures can be set between 2~99 times, or unlimited ( $\infty$ ).)

## 3

Press the **OK** button to apply the setting, and press the **MENU** button to go back to shooting mode.

## 4

Press the shutter button to start the interval timer shooting.

- During the interval timer shooting, the next exposure interval begins and the numbers of remaining exposures will be displayed.
- When the focus mode is set to AF, the AF will be locked at the first frame. From the second frame, pictures will be taken with the same focus position as the first frame.
- If the selected interval is short, the camera may start to take the next image before the display returns to the shooting mode.
- Exposure value is measured at each interval shooting. If you wish to take pictures with the same exposure value, set the Exposure Mode to Manual Exposure or fix the exposure value by pressing the **AEL** Button before shooting.
- To terminate the interval timer shooting, press the Shutter button.

## WARNING

- The following functions or settings cannot be used in combination.

Bracketing, HDR, Electronic Stabilization, Fill Light, Flash photography, ISO sensitivity settings added with the [Composite Low ISO Expansion]
---

- The interval timer shooting will be terminated automatically if the battery is empty. We recommend using the AC adapter "SAC-7P" (sold separately) (P.159).
- Once you set the Interval Timer, the camera will continuously hold that Interval Timer. To dismiss the Interval Timer, switch to another modes in [**Drive Mode**].
- Depending on the settings, it takes time process the image. It may make the actual interval time longer than the selected time.

# STABILIZATION

---

Configure settings for the Stabilization function.

Select [📷/👤 SHOOT] → [Stabilization] → [Lens Optical Stabilization] or [Electronic Stabilization], and specify [On] or [Off].

## LENS OPTICAL STABILIZATION

---

This function allows you to turn the lens with the stabilization function installed on or off. When the Stabilization switch (OS switch, etc.) is provided on the lens side, operate the switch on the lens side.

You can also select [📷/👤 SHOOT] → [Lens Function Settings] → [Optical Stabilization] to set this function.

## ELECTRONIC STABILIZATION

---

**(CINE/STILL)** For still image shooting, this function combines multiple images and generates an image with reduced camera shake.

For movie shooting, this function generates a video with reduced camera shake while combining multiple frames before and after the target.

## CAUTION

- [Electronic Stabilization] cannot be simultaneously used with [Lens Optical Stabilization].
- In STILL mode, an image is recorded at a narrow angle of view of approximately 2.5%.
- The range of shutter speeds able to be selected (shutter's working range) is limited from 1/4000 sec to 1/4 sec.
- The range of ISO sensitivity able to be selected is limited from ISO 100 to 6400.
- The following functions or settings cannot be used in combination.

Drive Mode: Continuous, Interval Timer, Bracketing, HDR, Fill Light, ISO sensitivity settings added with the [Composite Low ISO Expansion], Flash photography, Image Quality: DNG, DNG+JPEG, Format: CinemaDNG
--

- Electronic Stabilization is not available in the following frame rates.

119.88 fps、 100 fps
---------------------

## ISO SENSITIVITY SETTING



You can set the ISO sensitivity for shooting.

To set the ISO sensitivity, open the Quick Set menu or select [CAMERA / PEOPLE SHOOT] → [ISO Sensitivity Settings] → [ISO Sensitivity].

<b>ISO Auto (ISO Auto)</b> (Default)	The sensitivity is automatically set depending on the brightness. ( <b>100 to 6400</b> )
<b>ISO 100 to 25600</b>	The sensitivity is fixed to each value.

You can change the ISO sensitivity setting step.

[CAMERA / PEOPLE SHOOT] → [ISO Sensitivity Settings] → [ISO Sensitivity Step]

<b>1 EV</b>	<b>1/3 EV (Default)</b>
-------------	-------------------------

## ISO SENSITIVITY EXPANSION

This function allows you to expand the ISO sensitivity setting range.

[CAMERA / PEOPLE SHOOT] → [ISO Sensitivity Settings] → [ISO Sensitivity Expansion]

<b>Composite Low ISO Expansion</b>	<b>High ISO Expansion</b>
------------------------------------	---------------------------

When each of them is set to [On], expanded sensitivity is added. (Added sensitivity settings are underlined.)

## COMPOSITE LOW ISO EXPANSION

---

### (STILL)

This function allows you to take multiple images at one time, produce the same status as the automatic synthesis or low sensitivity shooting, and shoot photographs with rich gradation and noises reduced.

<b>ISO 6 - 80</b>	An image equivalent to each level of sensitivity is obtained.
<b>ISO 6, 12, 25, 50</b> (for 1 EV step)	

### CAUTION

- Image misalignment may occur when the subject is moving rapidly or when the shutter speed is slow.
- This function cannot be set to the lower limit of **[ISO Auto]**.
- Between ISO 6 and ISO 80, the selectable range of shutter speeds and the operating range change depending on the ISO sensitivity setting.
- Image misalignment may occur when the subject is moving rapidly or when the shutter speed is slow.

Drive Mode: Continuous, Interval Timer, Bracketing, HDR, Fill Light, Electronic Stabilization, Flash photography
--

## HIGH ISO EXPANSION

---

This function allows you to expand the ISO sensitivity in the high sensitivity side.

The following sensitivities are added.

<b>ISO 32000 - 102400</b>	<b>ISO 51200, 102400</b> (for 1 EV step)
---------------------------	---

### CAUTION

- This function enables shooting in dark environments, however, noises are likely to occur, which may reduce the resolution.

## ISO AUTO SETTINGS

### (CINE/STILL)

Specify the lowest or highest limit of the ISO sensitivity in the ISO Auto mode as well as the lowest limit of the shutter speed (maximum shutter angle) in **P** and **A** mode.

  **SHOOT**] → [ISO Sensitivity Settings] → [Auto Settings]

<b>ISO Lowest Limit</b>	<b>100 to 20000</b> (High ISO Expansion: Max. <b>80000</b> )
<b>ISO Highest Limit</b>	<b>125 to 25600</b> (High ISO Expansion: Max. <b>102400</b> )

### Shutter Speed Slowest Limit

<b>Auto (Faster)</b>	Set to a faster shutter speed than the standard by two levels.
<b>Auto (Fast)</b>	Set to a faster shutter speed than the standard by one level.
<b>Auto</b> (Standard) (Default)	Set to approximately one second of the focal length of the lens.
<b>Auto (Slow)</b>	Set to a slower shutter speed than the standard by one level.
<b>Auto (Slower)</b>	Set to a slower shutter speed than the standard by two levels.
<b>1/8000 sec. to one sec.</b>	Set to each shutter speed.

- The items and options above are changed to the following options when CINE mode (CINE style/angle) is selected.

### Maximum Shutter Angle

<b>Auto (Narrower)</b>	Set to a narrower shutter angle than the standard by two levels.
<b>Auto (Narrow)</b>	Set to a narrower shutter angle than the standard by one level.
<b>Auto</b> (Standard) (Default)	Basically, set the shutter angle to 180°.
<b>Auto (Wide)</b>	Set to a wider shutter angle than the standard by one level.
<b>Auto (Wider)</b>	Set to a wider shutter angle than the standard by two levels.
<b>1.1° to 360° *</b>	Set to each shutter angle.

\* In CINE mode, the available shutter speed (shutter angle) varies depending on the frame rate setting.

## IMAGE FILE SETTING

---

### (STILL)

Set the image quality, image size, and aspect ratio of still images.

## IMAGE QUALITY SETTING

---



Set the format of record images or the image quality of JPEG images.

Quick Set menu, or [**SHOOT**] → [Image Settings] → [Image Quality].

DNG+J	<b>DNG+JPEG</b>	DNG (RAW) + FINE(JPEG) simultaneous
DNG	<b>DNG</b>	DNG (RAW)
FINE	<b>FINE (Default)</b>	JPEG • High quality image
NORM.	<b>NORMAL</b>	JPEG • Standard quality image
BASIC	<b>BASIC</b>	JPEG • File size priority

### CAUTION

- DNG + JPEG and DNG cannot be used in combination with the following function.

HDR, Electronic Stabilization
-------------------------------

**You can specify the memory bit count of DNG images.**

Quick Set menu, or [**SHOOT**] → [Image Settings] → [DNG Quality].

<b>12 bit</b>	<b>14 bit (default)</b>
---------------	-------------------------

- Setting to [14bit] provides a rich gradation.

## TIP

- DNG (RAW format) is a record format based on the material properties. Development process by **SIGMA Photo Pro**, etc. is required. **SIGMA Photo Pro** can be downloaded free of charge from our website. Sigma recommends that you always update **SIGMA Photo Pro**.

[sigma-global.com/en/software/](http://sigma-global.com/en/software/)

- If necessary, you can create JPEG images from DNG images with the camera. Refer to "**DNG Development**" (P.133).
- DNG is the RAW image data that is developed by Adobe Systems Incorporated.

## IMAGE SIZE SETTING



Set the number of record pixels (image size) of an image.

Quick Set menu, or [CAMERA SHOOT] → [Image Settings] → [Image Size]

HIGH	<b>HIGH</b> (Default)	24M	6,000 x 4,000 (When it is set as 3:2)
MED	<b>MED</b>	12M	4,240 x 2,832 (When it is set as 3:2)
LOW	<b>LOW</b>	6M	3,008 x 2,000 (When it is set as 3:2)

- When the image quality is set to DNG+JPEG, both the DNG and JPEG files are recorded with the specified image size.

## CAUTION

- The selectable image sizes are limited depending on the image quality setting.

		Image Quality						
		DNG+J		DNG		FINE	NORM.	BASIC
		14 bit	12 bit	14 bit	12 bit			
Image Size	HIGH	○	○	○	○	○	○	○
	MED	×	×	×	×	○	○	○
	LOW	△	○	△	○	○	○	○

○: Available    ×: Unavailable    △: Available, however, the bit depth is changed to 12 bits.

## ASPECT RATIO SETTING



Set the aspect ratio of an image.

Quick Set menu, or [ SHOOT] → [Image Settings] → [Aspect Ratio]

<b>21:9</b>	Aspect Ratio similar to those of wide screens used in cinema.
<b>16:9</b>	Aspect Ratio the same as those of high vision TVs.
<b>3:2</b>	Aspect Ratio the same as those of 35mm film cameras.
<b>A Series (<math>\sqrt{2}</math>:1)</b>	The aspect ratio is the same as the general A series paper size.
<b>4:3</b>	Aspect Ratio the same as those of traditional TVs and PC screens.
<b>7:6</b>	Aspect Ratio is the same as those of 6x7 film cameras.
<b>1:1</b>	Aspect Ratio is the same as those of 6x6 film cameras.

- The image of each aspect ratio is cut and created from an image of the basic aspect ratio, "3:2", of this product.

### TIP

- A DNG image can be changed to another aspect ratio using **SIGMA Photo Pro** or the DNG Development function of the camera.

When shooting with aspect ratio other than 3:2, the frame is normally displayed in black. By making it semi-transparent, it is possible to use it as a sports finder which allows users to check the surrounding areas of the image.

[ SHOOT] → [Outer Frame]

<b>Black (Default)</b>	<b>Semi-transparent</b>
------------------------	-------------------------



# MOVIE RECORD SETTING

## (CINE)

Set the record format, resolution, or frame rate of a movie.

## RECORD FORMAT



Set the record format and quality of a movie.

Quick Set menu, or [CAMERA] SHOOT] → [Record Settings] → [Format].

<b>CinemaDNG</b>	RAW-format file in movie Development process is required.
<b>MOV (Default)</b>	File format available for editing images.

- If CinemaDNG is selected, [Bit Depth] is displayed in [Record Settings]. Select the desired memory bit count.

<b>8 bit</b>	<b>10 bit</b>	<b>12 bit</b>
--------------	---------------	---------------

## CAUTION

- Data recorded with CinemaDNG consists of multi-still DNG data (extension: .DNG) and a single audio file (extension: .WAV). For details, refer to "SETTING FROM THE [SYSTEM] MENU" - "File Name / Number" (P.140).
- CinemaDNG cannot be used in combination with the following function.

HDR, Electronic Stabilization, Director's Viewfinder
--

- If MOV is selected, [**Compression**] is displayed in [**Record Settings**]. Select the desired compression format.

<b>ALL-I</b> (All-Intra)	Data is compressed in frame units. The file size is enlarged, however, image degradation does not occur during editing.
<b>GOP</b> (Default)	Compression format with the file size prioritized. Available for longer periods of shooting.

## RESOLUTION

---



Set the resolution (size) of a movie.

Quick Set menu, or [**SHOOT**] → [**Record Settings**] → [**Resolution**]

<b>UHD</b> (Default)	3840 x 2160
<b>FHD</b>	1920 x 1080

## FRAME RATE

---

Set the frame rate (the number of frames per second).

Quick Set menu, or [**SHOOT**] → [**Record Settings**] → [**Frame Rate**]

<b>23.98 fps</b> (Default)	<b>24 fps</b>	<b>29.97 fps</b>	<b>50 fps</b>	<b>100 fps</b>
	<b>25 fps</b>	<b>48 fps</b>	<b>59.94 fps</b>	<b>119.88 fps</b>

## CAUTION

- The selectable frame rates are limited depending on the resolution setting.

## BIT RATE AND COMPATIBLE MEDIA

The below table shows the correspondence between the movie bit rate and compatible media depending on a combination of video record settings.

○: Available    ×: Unavailable

## CAUTION

- Operation is not guaranteed for all media.

## CinemaDNG

Resolution	Bit depth	Frame rate (fps)	Bit rate (Mbps)	Compatible media	
				SSD	SD UHS-II
UHD	12bit	29.97	3020	○	×
		25	2520	○	×
		24	2420	○	×
		23.98	2400	○	×
	10bit	29.97	2500	○	×
		25	2090	○	×
		24	2010	○	×
		23.98	2000	○	×
	8bit	29.97	2000	○	×
		25	1670	○	○
		24	1610	○	○
		23.98	1600	○	○
FHD	12bit	100	2540	○	×
		59.94	1530	○	○
		50	1270	○	○
		48	1220	○	○
		29.97	760	○	○
		25	640	○	○
		24	610	○	○
		23.98	610	○	○
	10bit	119.88	2540	○	×
		100	2120	○	×
		59.94	1280	○	○
		50	1060	○	○
		48	1020	○	○
		29.97	640	○	○
		25	530	○	○
		24	510	○	○
23.98	510	○	○		

## CinemaDNG

Resolution	Bit depth	Frame rate (fps)	Bit rate (Mbps)	Compatible media	
				SSD	SD UHS-II
FHD	8bit	119.88	2050	○	×
		100	1710	○	×
		59.94	1020	○	○
		50	850	○	○
		48	820	○	○
		29.97	510	○	○
		25	430	○	○
		24	410	○	○
		23.98	410	○	○

- Please check our website for the latest information about compatible media.

[sigma-global.com/en/special/fp/acc\\_recommend/](http://sigma-global.com/en/special/fp/acc_recommend/)

## MOV

Compression	Resolution	Frame rate (fps)	Bit rate (Mbps)	Compatible media	
				SSD	SD
ALL-I	UHD	29.97	440	○	○
		25	440	○	○
		24	440	○	○
		23.98	440	○	○
	FHD	119.88	440	○	○
		100	440	○	○
		59.94	240	○	○
		50	240	○	○
		48	240	○	○
		29.97	140	○	○
		25	140	○	○
		24	140	○	○
		23.98	140	○	○

## MOV

Compression	Resolution	Frame rate (fps)	Bit rate (Mbps)	Compatible media	
				SSD	SD
GOP	UHD	29.97	120	○	○
		25	120	○	○
		24	120	○	○
		23.98	120	○	○
	FHD	119.88	100	○	○
		100	100	○	○
		59.94	70	○	○
		50	70	○	○
		48	70	○	○
		29.97	60	○	○
		25	60	○	○
		24	60	○	○
		23.98	60	○	○

- For ALL-I recording, SSDs and SD cards with a writing speed of 60 MB/s or more are recommended.

## DC CROP (SUPER35) MODE

With the APS-C format lens attached, this product provides DC Crop mode to automatically switch the record range of the image sensor. You can also manually select On/Off of DC Crop mode.

### CAUTION

- You cannot select On/Off of DC Crop mode depending on the lens.

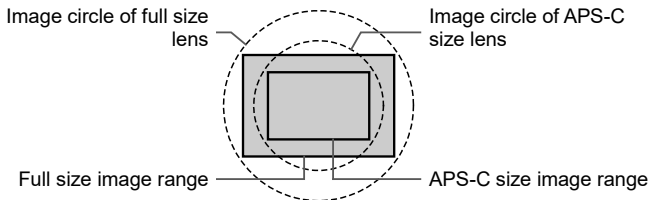

To set the value, select [📷/👤 SHOOT] → [DC Crop Mode\*].

\* "DC Crop (Super 35) Mode" is displayed in CINE mode.

<b>Off</b>	Records the full size image range.
<b>On</b>	Records the APS-C size image range.
<b>Auto</b> (Default)	The image range is switched depending on the attached lens.



The DC Crop mode icon is displayed in DC Crop mode.

- When a full size lens is mounted and DC Crop mode [**On**] is selected, the peripheral areas in the image will be cut off and the angle of view shifts 1.5 times to the telephoto end, when it is compared to the mode [**Off**].
- In STILL mode, the image size in DC Crop mode is set as shown below.

📷HIGH	<b>HIGH</b> (Default)	9.8M	3,840 x 2,560 (When it is set as 3:2)
📷MED	<b>MED</b>	5M	2,736 x 1,824 (When it is set as 3:2)
📷LOW	<b>LOW</b>	2.5M	1,920 x 1,280 (When it is set as 3:2)

- In CINE mode, the resolution (UHD/FHD) remains unchanged even when DC Crop mode is selected.

## CAUTION

- When an APS-C size lens is mounted and DC Crop mode [**Off**] is selected, there will be vignetting in the image and the resolution might not be sufficient due to the larger sensor size.

- Combination of Image Quality • Image Size • Aspect Ratio results in approximate file size (MB) per image as follows.  
(The file sizes change depending on subjects.)

## DC Crop Mode [Off]

### Image Size [HIGH]

Aspect Ratio	Image Size	Image Quality				
		DNG(14bit)	DNG(12bit)	FINE	NORM.	BASIC
21:9	15M (6000×2576)	52.1	46.3	11.1	6	4.5
16:9	20M (6000×3376)	55.6	49.7	14.6	7.8	5.9
3:2	24M (6000×4000)	58.3	52.4	17.2	9.2	6.9
A Size( $\sqrt{2}$ :1)	23M (5664×4000)	57.3	51.4	16.3	8.7	6.6
4:3	21M (5344×4000)	56.4	50.5	15.4	8.2	6.2
7:6	20M (4960×4000)	54.5	48.6	13.4	7.2	5.4
1:1	16M (4000×4000)	52.5	46.7	11.5	6.2	4.7

### Image Size [MED]

Aspect Ratio	Image Size	Image Quality				
		DNG(14bit)	DNG(12bit)	FINE	NORM.	BASIC
21:9	7.7M (4240×1824)	-	-	5.6	3	2.3
16:9	10M (4240×2392)	-	-	7.3	3.9	3
3:2	12M (4240×2832)	-	-	8.7	4.7	3.5
A Size( $\sqrt{2}$ :1)	11M (4000×2832)	-	-	8.2	4.4	3.3
4:3	11M (3776×2832)	-	-	7.7	4.2	3.1
7:6	10M (3520×2832)	-	-	6.8	3.7	2.8
1:1	8M (2832×2832)	-	-	5.8	3.1	2.4

### Image Size [LOW]

Aspect Ratio	Image Size	Image Quality				
		DNG(14bit)	DNG(12bit)	FINE	NORM.	BASIC
21:9	3.9M (3008×1288)	-	11.7	2.8	1.6	1.2
16:9	5.1M (3008×1688)	-	12.6	3.7	2	1.5
3:2	6M (3008×2000)	-	13.2	4.4	2.4	1.8
A Size( $\sqrt{2}$ :1)	5.7M (2832×2000)	-	13	4.1	2.2	1.7
4:3	5.3M (2672×2000)	-	12.7	3.9	2.1	1.6
7:6	5M (2480×2000)	-	12.3	3.4	1.9	1.4
1:1	4M (2000×2000)	-	11.8	2.9	1.6	1.2

## DC Crop Mode [On]

### Image Size [HIGH]

Aspect Ratio	Image Size	Image Quality				
		DNG(14bit)	DNG(12bit)	FINE	NORM.	BASIC
21:9	6.3M (3840×1648)	22.2	19.7	4.6	2.5	1.9
16:9	8.3M (3840×2160)	23.6	21.1	6	3.2	2.5
3:2	9.8M (3840×2560)	24.7	22.2	7.1	3.8	2.9
A Size ( $\sqrt{2}$ :1)	9.3M (3616×2560)	24.3	21.8	6.7	3.6	2.7
4:3	8.7M (3408×2560)	23.9	21.4	6.3	3.4	2.6
7:6	8.2M (3184×2560)	23.1	20.6	5.6	3	2.3
1:1	6.6M (2560×2560)	22.3	19.9	4.8	2.6	2

### Image Size [MED]

Aspect Ratio	Image Size	Image Quality				
		DNG(14bit)	DNG(12bit)	FINE	NORM.	BASIC
21:9	3.2M (2736×1168)	-	-	2.4	1.3	1
16:9	4.2M (2736×1536)	-	-	3.1	1.7	1.3
3:2	5M (2736×1824)	-	-	3.6	2	1.5
A Size ( $\sqrt{2}$ :1)	4.7M (2560×1824)	-	-	3.4	1.9	1.4
4:3	4.4M (2416×1824)	-	-	3.2	1.8	1.3
7:6	4.1M (2272×1824)	-	-	2.8	1.5	1.2
1:1	3.3M (1824×1824)	-	-	2.5	1.3	1

### Image Size [LOW]

Aspect Ratio	Image Size	Image Quality				
		DNG(14bit)	DNG(12bit)	FINE	NORM.	BASIC
21:9	1.6M (1920×824)	-	5.1	1.2	0.7	0.5
16:9	2.1M (1920×1080)	-	5.4	1.6	0.9	0.7
3:2	2.5M (1920×1280)	-	5.7	1.8	1	0.8
A Size ( $\sqrt{2}$ :1)	2.3M (1808×1280)	-	5.6	1.7	1	0.7
4:3	2.2M (1712×1280)	-	5.5	1.6	0.9	0.7
7:6	2M (1584×1280)	-	5.3	1.4	0.8	0.6
1:1	1.6M (1280×1280)	-	5.1	1.2	0.7	0.5



# DIRECTOR'S VIEWFINDER



## (CINE)

This function simulates how an angle of view is changed depending on the setting information of the registered cinema camera and the focal length of the attached lens.

- The settings for three patterns can be saved and recalled.

## CAUTION

- The following functions or settings cannot be used in combination.

Frame Rate: 119.88 fps / 100 fps,    Format: CinemaDNG, Electronic Stabilization
---

- This setting is not available in STILL-like style.
- The focus frame is fixed to the center of **[Single]** and the M size.
- The time code and grid line are not displayed.
- The Image Magnification function is not available.

Select **[SHOOT]** → **[Director's Viewfinder]** and select a number you want to set (#1 to #3).

### 1

Specify **[Brand]**, **[Model]**, and **[Settings]** as simulation conditions.

### 2

Set **[Surround View]**.

<b>Off</b>	Movies wider than 16:9 are fitted crosswise, and movies taller than 16:9 are fitted lengthwise.
<b>Black</b>	The area outside the frame range is masked in black without fitting to the screen.
<b>Semi-transparent</b>	The area outside the frame range becomes semi-transparent without fitting to the screen, so you can check the area outside the frame range.

- The below table shows the correspondence between the registered cameras and setting information.

Brand	Model	Settings	Brand	Model	Settings		
ARRI	ARRICAM / ARRIFLEX	ANSI S35 4-Perf. ANSI S35 3-Perf.	ARRI	ALEXA XT	16:9 DNxHD 16:9 ProRes HD 16:9 ProRes 2K 16:9 ProRes 3.2K 4:3 ProRes 2K (x2) 4:3 ARRIRAW Cropped(x2) 4:3 ARRIRAW Full (x2) Open Gate ARRIRAW		
	ALEXA LF / ALEXA Mini LF	LF 16:9 LF 16:9 (x1.25) LF 16:9 (x1.3) LF 16:9 (x1.5) LF 16:9 (x1.65) LF 16:9 (x1.8) LF 16:9 (x2) LF 2.39:1 Open Gate			3.8K 16:9 4K 2.39:1 4K 17:9 4K 4:3 (x1.25) 4K 4:3 (x1.3) 4K 4:3 (x1.5) 4K 4:3 (x1.65) 4K 4:3 (x1.8) 4K 4:3 (x2) 4K 6:5 (x1.25) 4K 6:5 (x1.3) 4K 6:5 (x1.5) 4K 6:5 (x1.65) 4K 6:5 (x1.8) 4K 6:5 (x2)		
	ALEXA SXT	16:9 ProRes HD/2K 16:9 ProRes 3.2K/4K UHD 16:9 ARRIRAW 2.8K 16:9 ARRIRAW 3.2K 4:3 2.8K (x2) 6:5 ProRes (x2) 6:5 ARRIRAW (x2) Open Gate 3.4K Open Gate 4K Cine			SONY	VENICE	5.7K 16:9 6K 2.39:1 6K 17:9 6K 17:9 (x1.25) 6K 17:9 (x1.3) 6K 17:9 (x2) 6K 1.85:1
	ALEXA Mini	ProRes S16 HD ProRes HD ProRes HD Ana.(x2) ProRes 2K ProRes 2.39:12KAna.(x2) ProRes 4:3 2.8K ProRes 3.2K ProRes 4K UHD ARRIRAW 16:9HDAna.(x2) ARRIRAW 2.39:1 2K Ana. ARRIRAW 2.8K ARRIRAW 4:3 2.8K(x2) ARRIRAW Open Gate 3.4K	MONSTRO 8K	7K FF 6K FF 4K FF			
	AMIRA	MPEG-2 HD ProRes S16 HD ProRes HD ProRes 2K ProRes 3.2K ProRes 4K UHD ARRIRAW 2.8K	RED	DRAGON 6K			6K FF
			EPIC MX 5K	5K FF			
	ALEXA 65	4K UHD		GEMINI 5K	5K Full Height 1.7:1 5K Full Height 6:5 5K FF		
				Komodo	6K FF		

- The pre-setting for using an anamorphic lens is also registered in this viewfinder. You can desqueeze a video squeezed with an anamorphic lens to display it.
- A movie is recorded based on the setting described in **[Record Settings]** (P.73) of the Set-up menu.
- After using this function, select **[Director's Viewfinder]** → **[Off]**.

## CAUTION

- Only when playback is done on this product, the simulation conditions specified at the time of shooting and the surround view information are applied, enabling you to check the effect.
- DC Crop mode is released; therefore, the part around the screen may become dark or lead to a resolution failure.
- You can take a picture using the release button even when in Director's Viewfinder mode. (The setting of the recorded still image is the same as that of the still image recorded in CINE mode (P.44).) Still images are recorded with various effects of the Director's Viewfinder.

## PLAYBACK

The playback method is the same as that of a regular movie or still image. For details on how to play a video, refer to "**PLAYING BACK A MOVIE**" (P.125).



The image recorded in Director's Viewfinder mode is marked by the setting icon.

- The time code, number of pixels, and aspect ratio are not displayed.
- **[Save As JPEG]** is only available to cut out a photo from a video.
- No changes can be made to the simulation conditions for recording and the surround view setting.

# AUDIO RECORD SETTING

## (CINE)

Configure settings for sounds that are recorded simultaneously in a movie.

To set this option, select [ SHOOT] → [Audio Record].

<b>Off</b>	No sounds are recorded for movie shooting.
<b>On (Default)</b>	Sounds are also recorded for movie shooting.

## Gain Adjustment

This function allows you to make a level adjustment while checking the currently input sound using the audiometer.

[ SHOOT] → [Audio Record] → [On] → [Gain Adjustment]

<b>Auto</b>	(Default) The camera adjusts the optimal level.	
<b>Manual</b>	<b>Ch.1 / 2 Sync.</b>	<b>Off</b> Allows you to adjust Ch.1 and Ch.2 independently. <b>On</b> Applies the Ch.1 setting to Ch.2.
	<b>Ch.1 Adjustment Amount</b>	Adjusts Ch.1.
	<b>Ch.2 Adjustment Amount</b>	Adjusts Ch.2.

**Ch.1:** Microphone (L), **Ch.2:** Right microphone (R)

Select the desired option, and use the button to adjust the level.

- The level can be adjusted between +6dB and -36dB in 3dB-pitch increments.
- You can adjust the baseline level of Auto. Select [**Auto**] → [**Adjustment Amount**], and adjust the baseline level while checking on the level meter.
- Gain Adjustment (Auto Gain Adjustment) can be assigned to the Quick Set menu (P.36) or a custom button (P.116).

## Wind Noise Canceller

Reduces wind noises.

[ SHOOT] → [Audio Record] → [On] → [Wind Noise Canceller]

<b>Off (Default)</b>	Turns the noise reduction function off.
<b>On</b>	Turns the noise reduction function on.

# EXPOSURE COMPENSATION

---

If you want to intentionally overexpose or underexpose the picture, use this function.

Select [ / SHOOT] → [Exposure Compensation] or use the Rear dial to set the compensation value.

- Exposure compensation can be set in 1/3 stop increments from +5.0 to -5.0 stops (When shooting a movie,  $\pm 3$  EV is applied.).

## CAUTION

- The exposure compensation will not disable automatically. After taking the picture, set the compensation value to  $\pm 0.0$  by rotating the Rear Dial.
- The exposure compensation function cannot be used with Manual Operation mode except when [ISO Auto] is selected.

# METERING MODE

---



The camera has three advanced metering modes.

To set the mode, open the Quick Set menu (except when the camera is in CINE mode (CINE style)) or select [ / SHOOT] → [AE Metering Mode].

	<b>Evaluative Metering</b> (Default)		<b>Spot Metering</b>
	<b>Center Weighted Average Metering</b>		

## Evaluative Metering

The camera divides its screen into 256 and measures the brightness of the scene by independently measuring each segment of the focusing screen and analyzing the correct exposure for the main subject in any lighting situation.

## Center Weighted Average Metering

The camera will measure the average brightness of the entire scene with additional emphasis on the center area. It will determine the most suitable exposure with respect to lighting conditions.

## [] Spot Metering

The camera will measure the brightness only inside of the selected focusing point on the color LCD monitor. This mode is suitable when you wish to set exposure for a portion of the scene.

## AEL BUTTON



The **AEL** button is available to do the shooting with the specified exposure in Auto mode.

The **AEL** button can be assigned to the following functions in addition to the normal AE lock function.

To set this option, select [ /  SHOOT] → [Custom Buttons Functions] → [AEL].

<b>AEL</b> (Default)	The camera will fix and memorize the exposure value whilst the <b>AEL</b> button is depressed. Until the <b>AEL</b> button is pressed again, images are taken with the same exposure.
<b>AEL</b> (Pressed)	The exposure is fixed only while the <b>AEL</b> button is being pressed.
<b>AFL</b>	Press the <b>AEL</b> button to lock the focus. Images will be taken with the same focusing point until the button is pressed again.
<b>AFL</b> (Pressed)	The focus is locked only while the <b>AEL</b> button is being pressed.
<b>AF-ON</b>	The Autofocus activates when the <b>AEL</b> button is being pressed.
<b>AEL+AFL</b>	Press the <b>AEL</b> button to lock both AE and Focus simultaneously. Until the <b>AEL</b> button is pressed again, images are taken with the same exposure and focusing point.
<b>AEL+AFL</b> (Pressed)	Both AE and Focus are locked simultaneously only while the <b>AEL</b> button is being pressed.
<b>LV</b> Magnification	The operation becomes the same as when the  button is pressed during shooting. For more information, refer to [IMAGE MAGNIFICATION USING THE OK BUTTON] (P.60).
<b>Depth of Field</b> Preview	For more information, refer to [DEPTH OF FIELD PREVIEW] (P.61).

# WHITE BALANCE SETTING (WB)



In general use, the white balance is adjusted automatically; however, if the desired colors are not obtained, you can configure a setting from the preset white balance.

To set this option, open the Quick Set menu or select [CAMERA / PEOPLE SHOOT] → [White Balance].

	Mode	COLOR TEMP.	DESCRIPTION
AWB	Auto (Default)	-	Adjusted automatically. Use your camera in this mode for regular photography
AWB •••	Auto (Lighting Source Priority)	-	Select this setting to allow the camera to automatically determine the appropriate white balance while valuing the color and atmosphere of the light source.
☀	Daylight	Approx.5400 K	Sunny outdoor location
☀ /	Shade	Approx.8000K	Shaded area in sunny outdoor location
☁	Overcast	Approx.6500K	Cloudy outdoor location
💡	Incandescent	Approx.3000K	Under lighting of incandescent light bulb
💡 /	Fluorescent	Approx.4100K	Under white fluorescent lamp
⚡WB	Flash	Approx.7000K	When compatible flash is used
K	Color Temperature	-	Select this setting to adjust the white balance by setting the color temperature to a numerical value.
📷 1~3	Custom 1 to 3	-	Select this setting to determine the white balance based on the image taken. (Page 89)

## ADJUSTING WHITE BALANCE

Each White Balance can be adjusted.



After choosing White Balance, press the ➤ button to display the White Balance Adjustment screen.

To set White Balance from Quick Set Menu, select preferred White Balance, and press the **AEL** button to display the White Balance Adjustment screen.



**2**

Press the **<>** buttons to adjust.

- B stands for Blue, A for Amber, M for Magenta, and G for Green. The image will be adjusted with colors in the movement direction.
- In each direction, adjustments can be made for up to eight steps.

**3**

Press the **OK** button to apply the setting. To go back without changing the setting, press the **MENU** button.

- To reset, press the **MODE** button.



The adjustment value is displayed to the right of the White Balance Icon.

## SETTING THE VALUE OF COLOR TEMPERATURE

White Balance can be adjusted by setting the color temperature in numerical value.



**1**

Select [**Color Temperature K**] and press the **>** button to display the Color Temperature setting screen. (After selecting [**Color Temperature K**] and pressing the **OK** button, images can be taken at the value set previously.)

To set from the Quick Set Menu, select [**K**], and press the **AEL** button to display the Color Temperature setting screen. (After selecting [**K**] and pressing the **OK** button or the shutter button “half-way”, images can be taken at the value set previously.)



## 2

Use the **<>** button or the Front/Rear dial to set the value.

(Press the **MODE** button to set it to 5000K.)

### **White Balance can also be adjusted when setting the color temperature.**

Press the **AEL** button to display the White Balance Adjustment screen on the Color Temperature Setting screen.

Follow the instruction **2** and onwards in [ADJUSTING WHITE BALANCE] in the previous page.

### **TIP**

- Light source can be reddish or bluish, the color of light described as absolute temperature (K: Kelvin) is called “Color Temperature”. The lower the color temperature is, the more reddish the color of light turns out, and the higher, the more blueish. Please refer P.87 for the approximate color temperature of the light source.

## **SETTING A CUSTOM WHITE BALANCE**

---

Select this setting to determine the white balance based on the image taken.

- Up to three Custom White Balances can be registered (Custom 1 to 3).

### **1**

Select [**Custom 1**], [**Custom 2**], or [**Custom 3**] and press the **>** button to display the Custom White Balance Setting screen. (When the **OK** button is pressed after selecting [**Custom**], the previous white balance setting will be set.)

When a custom white balance is set in the Quick Set menu, select one of [**1 to 3**] and press the **AEL** button to display the Custom White Balance Setting screen. (By pressing the **OK** button or half-pressing the shutter button after selecting [**1 to 3**], the previous setting will be applied.)

### **2**

Under the lighting conditions that will be used for the final photograph, frame a white colored object, such as a sheet of white paper or a white wall, so that it fills the frame in the center of the color LCD monitor. Then use the Manual focus function to adjust the focus point (the focus point does not have to be perfectly in position).

### 3

Press the **AEL** button and import the custom white balance image.

If a valid white balance settings was captured, the message **"White balance image captured successfully"** will appear on the color LCD monitor to indicate that the white balance image was captured successfully.

If the capture was not successful, **"Failed. Please retry the custom WB capture."** will be displayed on the color LCD monitor. Press the **AEL** button to capture a white balance image once again.

- To dismiss the capture, press the **MENU** button.

## ADDING A NOTE TO CUSTOM WHITE BALANCE

---

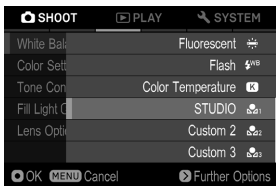

A note can be added to a Custom White Balance. The note is reflected in the "White Balance" sub menu and is useful when needing to use previously registered custom white balance.

- It is possible to enter up to 48 single-byte characters and symbols.

### 1

On the Custom White Balance Capture screen, pressing the **▼** button displays the Note Input screen.

### 2

Input the texts. For the procedure to input texts, please refer to **[ENTERING INFORMATION]** of **[COPYRIGHT INFORMATION]** (P.143).

- When deleting a note attached to a Custom White Balance, delete all the text from the Note input screen.

## CAUTION

- The note attached to the Custom White Balance is not recorded in the image information data.

# COLOR MODE

It is possible to select the desired Color mode depending on the shooting conditions. In addition to the above settings, Monochrome photography or movie can be selected.

To set the mode, press the [COLOR] button, or select [📷 SHOOT] → [Color Settings] → [Color Mode] (in CINE mode, select [👤 SHOOT] → [Color Mode]).

<b>STD.</b> Standard (Default)	Standard color mode for various situations.
<b>VIVID</b> Vivid	Saturation and contrast are enhanced for making pictures appear vivid.
<b>NTR.</b> Neutral	Subdued saturation and contrast makes images natural.
<b>PORT.</b> Portrait	This color mode makes skin tone soft. It is ideal for portraits.
<b>LAND</b> Landscape	This mode makes blue and green more vivid and emphasizes pictures.
<b>CINE</b> Cinema	This mode reduces saturation and emphasizes shadows to recreate an image like in a cinema.
<b>T&amp;O</b> Teal and Orange	Highlights orange colors such as a flesh color and turquoise of a complementary color to emphasize images.
<b>Sun R.</b> Sunset Red	This mode emphasizes red color rendering, and expresses the scenes, such as sunsets, more impressively.
<b>For G.</b> Forest Green	This mode emphasizes green color rendering, and expresses greens, such as plants, more impressively.
<b>Pow B.</b> Powder Blue	This mode is characterized by a refreshing blue color with a bright and transparent look.
<b>Fov B.</b> FOV Classic Blue	This mode recreates impressive blue sky, with the expression of rich blue tone.
<b>Fov Y.</b> FOV Classic Yellow	This mode recreates an impressive and rich color tone with the emphasis on yellow-like color.
<b>DUO.</b> Duotone	This mode creates images that have impressive gradation between shadows and highlights.
<b>MONO.</b> Monochrome	It is possible to take Monochrome pictures.

<b>OFF.</b> Off	Suitable for shooting that assumes development processing will be carried out. Images that are almost identical to the output from the image sensor can be obtained.
--------------------	--

Use the ◀▶ buttons to select the desired color mode, and use the ⬅➡ buttons to adjust the intensity of effect (up to ±5 in 1-step increments).



The selected color setting icon is displayed.  
(When [OFF] is selected, the icon is not displayed.)

## TIP

- In **SIGMA Photo Pro**, Monochrome mode is designed for DNG data capture using **MONO**. **Sigma Photo Pro** can convert Monochrome DNG images into color. (JPEG data cannot be returned to a color image.)

## CAUTION

- In **MONO**. (Monochrome) mode, if an option other than [B/W] (B&W) is selected for [Toning Effect] in [COLOR MODE DETAILED SETTING] (next section), you can adjust the effect.
- When developing DNG data with an Adobe Systems application, the color mode settings may not be reflected depending on the version of the application. Please check the up-to-date information.
- If [OFF] (Off) is selected, images may appear dark. However, do not apply exposure compensation; instead, adjust the brightness when performing development processing.
- [OFF] (Off) cannot be set in combination with the following functions or settings.

Color mode detailed setting, Fill Light, Fill Light BKT, HDR, Tone Control
--

## DUO. Duotone mode

This mode creates images that have impressive gradation between shadows and highlights.

In **DUO**. (Duotone) mode, use the  buttons to select a preset that matches the image.

- Tonal changes for each preset are roughly as follows.

	Shadow colors	Intermediate colors	Highlight colors
<b>R1</b>	Navy blue	Red	Orange
<b>OR1</b>	Dark green	-	Orange
<b>YE1</b>	Bluish purple	-	Yellow
<b>YG1</b>	Turquoise blue	-	Yellow green
<b>G1</b>	Turquoise blue	-	Light green
<b>G2</b>	Reddish brown	-	Light green
<b>B1</b>	Light reddish brown	-	Light green
<b>B2</b>	Black	-	Aqua
<b>P1</b>	Navy blue	Light purple	Pink
<b>M1</b>	Magenta	-	Ivory

## COLOR MODE DETAILED SETTING

With each color mode, image parameters (Contrast, Sharpness, and Saturation) can be adjusted to create preferred images.

### Contrast

Contrast can be increased by moving the cursor to + side, or decreased, preserving image detail, by moving the cursor to - side.

### Sharpness

It is possible to make the pictures appear sharper, by moving the cursor to + side, or softer by moving the cursor to - side.

### Saturation (Excluding Monochrome and Duotone)

It is possible to increase saturation thus making pictures appear vivid, if the cursor is moved to + side. Moving the cursor to - side, decreases saturation and makes images less vivid.



### Toning Effect (Only with Monochrome)

Monochrome images can be finished with preferred color tones.



<b>B/W</b> B&W (Default)	<b>R</b> Red	<b>WARM</b> Warm Tone	<b>SEPIA</b> Sepia	<b>G</b> Green
<b>BG</b> Blue Green	<b>B</b> Blue	<b>COLD</b> Cold Tone	<b>BP</b> Blue Purple	<b>P</b> Purple

**1**



Press the **AEL** button while the Color Mode Setting screen is being displayed, and open the Color Mode Detailed Setting screen.

- Pressing the  button temporarily stops the currently displayed screen, enabling you to make adjustments while checking a still image. To restart, press the  button again.

**2**

Use the  buttons to select the target parameter, and using the  or  button to apply the setting.

**3**

Use the  button to set the adjustment value (up to  $\pm 1.0$  in 0.2-step increments), and use the  button to apply the setting.



The icon of the currently adjusted parameter is displayed next to the color mode icon.

## TIP

- For DNG data, you can change the color mode or adjust a parameter using **SIGMA Photo Pro**.
- For CinemaDNG data, the color mode is applied only when images are viewed on the camera.

## TONE CONTROL

This function allows you to optimize a tone curve even in a scene with a high contrast, providing an image in natural tone.



Tone Control: Off



Tone Control: Strong



To set the Tone Control, press the **TONE** button or select [📷/👤 SHOOT] → [Tone Control].

<b>Off</b>	<b>Off</b>	Disables the effect.
	<b>Auto (Mild)</b> (Default)	Mild effect can be achieved.
	<b>Auto (Strong)</b>	Strong effect can be achieved.
<b>MANUAL</b>	<b>Manual</b>	Individually adjusts highlight or shadow. (Up to ±5 in 1-step increments)

- Pressing the **AEL** button temporarily stops the currently displayed screen, enabling you to make adjustments while checking a still image. To restart, press the **AEL** button again.

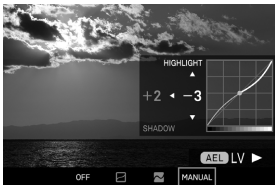

## MANUAL ADJUSTMENT

After selecting [**Manual**], use the <> buttons to select highlight or shadow, and use the ⬆️ buttons to adjust the intensity.

## CAUTION

- The following functions or settings cannot be used in combination.

Color Mode: [Off], [Duotone],

## Fill Light

### (STILL)

This function allows you to adjust the brightness so that dark parts become lighter, without changing the exposure of light parts in an image.

To set this option, open the Quick Set menu or select [📷 SHOOT] → [**Fill Light**]. (Up to ±5 in 0.2-step increments)

### TO CONFIRM THE EFFECT...

Press the **AEL** button while the Fill Light Setting screen is being displayed, and open the preview screen (still screen). To release the preview screen, press the **AEL** button again.

## CAUTION

- The following functions or settings cannot be used in combination.

Drive Mode: Continuous, Interval Timer, HDR, Electronic Stabilization Bracketing (Except Fill Light BKT.), Color Mode: [Off], [Duotone], ISO sensitivity settings added with the [Composite Low ISO Expansion]
--

## LENS OPTICS COMPENSATION

---

Specify whether or not to compensate for the following lens aberration.

<b>Distortion (Off/Auto)</b>	<b>Diffraction (Off/Auto)</b>
<b>Lateral Chromatic Aberration (Off/Auto)</b>	<b>Vignetting (Off/Auto)</b>
	<b>Color Shading</b>

To set this option, select [ /  SHOOT] → [Lens Optics Compensation].

## CAUTION

- In general use, set to "Auto" (default).
- Compensation cannot be set to [Off] depending on the lens.

## COLOR SHADING CORRECTION

---

This function allows you to compensate for color shading (phenomenon in which parts around the screen are colored).

### When you are using an L-mount lens:

Color shading is compensated for automatically. If necessary, you can make fine adjustments manually.

**1**



Select [ /  SHOOT] → [Lens Optics Compensation] → [Color Shading] → [Auto], and press the  button.

**2**



Press the **AEL** button to open the preview screen (still screen).



### 3

Use the  buttons to select [Red] or [Blue], and use the  or  button to apply the setting.

### 4

Use the  button to set the adjustment value (up to  $\pm 1.0$  in 0.2-step increments), and use the  button to apply the setting.



## CAUTION

- The adjusted value is reset when the lens is changed.

### When you are using a lens other than the L-mount lens:

You can compensate for the color shading of the lens that is attached by using a mount adapter manufactured by another company.

### 1

Select [ /  SHOOT] → [Lens Optics Compensation] → [Color Shading], select the desired column from [#1 to #10], and press the  button.

### 2

On the Compensation Capture screen, fill a monotonous screen without a color tone such as white or gray on the entire screen, and press the **AEL** button.

### 3

When compensation succeeds, the Compensation screen is displayed. If fine adjustment is required, press the  button, and make fine adjustment following step 3 and subsequent steps in the previous item.

## ENTERING LENS INFORMATION

### 4

When compensation is completed, press the  button to move to the lens information entry screen.



### 5

Enter information on the [Focal Length / Aperture Input] screen. When entering other information, open the [Note] screen. For details about how to enter a memo, refer to "ENTERING INFORMATION" of [COPYRIGHT INFORMATION] (P.143).

- To erase a memo, delete all characters on the Enter Memo screen.

## TO RESET COMPENSATION...

1

Select [ /  SHOOT] → [Lens Optics Compensation] → [Color Shading], select the column to reset, and press the **MODE** button on the Compensation Capture screen.

2

Select [**Yes**], and press the **OK** button to apply the setting. (This erases the compensation value and lens information.)

## CAUTION

- When [**CinemaDNG**] is selected as the format of CINE mode, Color Shading Correction is not available.

# BRACKETING

---

## (STILL)

This function allows you to perform shooting while automatically bracketing the setting value in the following five items.

<b>Exposure</b>	<b>White Balance</b>	<b>Fill Light</b>
<b>Focus</b>	<b>Color Mode</b>	

## CAUTION

- For white balance BKT, Fill Light BKT, and color mode BKT, image processing is performed for the specified number of pages based on the one-time shooting data, so the writing time becomes longer than it is for regular shooting.
- Bracketing is not automatically canceled. When shooting is completed, select [**Off**] from each bracketing item.
- The following functions or settings cannot be used in combination.

Drive Mode: Interval Timer, Fill Light (Excluding Fill Light BKT), HDR ISO sensitivity settings added with the [Composite Low ISO Expansion], Electronic Stabilization
--

- Exposure BKT and focus BKT cannot be used with the flash shooting.

1

Select [ SHOOT] → [**Bracketing**], and select the target item.

## 2

Press the  $\blacktriangleright$  button to select [On], and press the  $\blacktriangleright$  button to open the Further Options screen. (If you press the **OK** button while [On] is selected, shooting is performed with the previous setting value.)

## 3

Select the option you want to change on the Further Options screen. Then, press the **OK** button or the  $\blacktriangleright$  button to open the sub menu.

## EXPOSURE BKT

By setting the exposure judged as appropriate by the camera, it is possible to continuously take pictures with the exposure bracketed.

<b>Bracketing Number</b>	Number of shots (three or five)
<b>Bracketing Amount</b>	Up to $\pm 3$ steps in 1/3-step increments
<b>Bracketing Order</b>	<p>0 <math>\rightarrow</math> - <math>\rightarrow</math> + (Default)  appropriate exposure <math>\rightarrow</math> under exposure <math>\rightarrow</math> over exposure</p> <p>- <math>\rightarrow</math> 0 <math>\rightarrow</math> +  under exposure <math>\rightarrow</math> appropriate exposure <math>\rightarrow</math> over exposure</p> <p>+ <math>\rightarrow</math> 0 <math>\rightarrow</math> -  over exposure <math>\rightarrow</math> appropriate exposure <math>\rightarrow</math> under exposure</p>



## 4

Use the  $\diamond$  buttons to select a desired value, and press the **OK** button or the  $\blacktriangleright$  button to apply the setting.

## 5

When the setting is completed, the setting icon and compensation value are displayed.

- The operations in each Drive Mode are shown below.

<b>Single Capture</b>	An image is taken one frame at a time.
<b>Continuous</b>	Frames will be taken continuously by pressing and holding the shutter button.
<b>Self Timer</b>	Continuous shooting begins after the specified timer period expires.

- When the exposure mode is set to **M**, only the shutter speed will be changed. (When [ISO Auto] is selected, ISO varies.)

- Exposure BKT can be combined with exposure compensation. Bracketing is performed based on the compensation value specified in Exposure Compensation.
- You can check the shooting frame using the bar indicator of the icon.

#### Example: When five frames are taken

First frame	Second frame	Third frame	Fourth frame	Fifth frame

## FOCUS BKT

This function allows you to continuously take photographs with the focus position bracketed based on the focus position.

<b>Bracketing Number</b>	The number of pictures to be taken (3, 5, 7, 9, 11, 13, or 15)
<b>Bracketing Amount</b>	Up to $\pm 10$ levels in one-step increments
<b>Bracketing Order</b>	<p><b>0</b> → - → + (Default) Focal point → Front focus → Rear focus</p> <p><b>0</b> → +    Focal point → Rear focus</p> <p><b>0</b> → -    Focal point → Front focus</p>

- The focus shift per step varies depending on the lens.



**4**

Use the buttons to select a desired value, and press the **OK** button or the button to apply the setting.

**5**

Half-press the shutter button to return to the shooting mode. (The setting icon and bracketing amount are displayed.)

- The operations in each Drive Mode are shown below.

<b>Single Capture</b>	After focusing, hold down the shutter button; continuous shooting starts.
<b>Self Timer</b>	After focusing, hold down the shutter button; the timer is activated. When the specified timer period expires, continuous shooting starts.

- Continuous shooting cannot be simultaneously used with other functions.

## WHITE BALANCE BKT

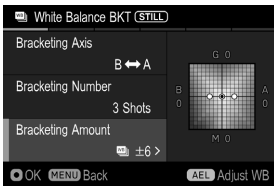



In a single shooting, several images with different white balances can be recorded.

<b>Bracketing Axis</b>	<b>B↔A</b> (Blue ↔ Amber) <b>M↔G</b> (Magenta ↔ Green)
<b>Bracketing Number</b>	The number of shots to be recorded (three or five)
<b>Bracketing Amount</b>	In 2-step increments up to ±16 EV



**4**

Use the  buttons to select a desired value, and press the **OK** button or the  button to apply the setting.

**5**

Half-press the shutter button to return to the shooting mode. (The white balance icon, bias direction, and bracketing amount appear.)

## ADJUSTING WHITE BALANCE

The standard value of the white balance can be finely adjusted.

**1**

On the White Balance Bracket Setting screen, press the **AEL** button to display the White Balance Adjustment screen.

**2**

Press the  buttons to adjust. If the current setting is used without changing the value, press the **MENU** button. The adjustment is canceled and the screen returns to the previous screen.

**3**

To confirm, press the **OK** button. After finalizing, pressing the **OK** button again returns the screen to the White Balance BKT Setting screen.

## COLOR MODE BKT

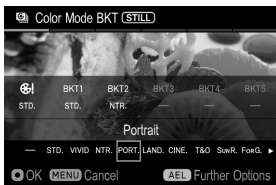

In a single shooting, several images with different color modes can be recorded.

	Currently-set Color Mode. (This setting can be changed using the same procedure.)
<b>BKT1 to BKT5</b>	Up to five Color Modes to be saved in a bracket can be selected.

### 4

Select from BKT1 to BKT5 by using the **<>** buttons and press the **OK** button.

### 5

From the list at the bottom of the screen, select the Color Mode to be allocated by using the **<>** buttons and press the **OK** button to confirm your selection.



- To cancel the color mode you allocated, select [ - ] (no allocation) from the list.

### 6

Half-press the shutter button to return to the shooting mode. (The setting icon and the number of recorded images are displayed.)

## COLOR MODE DETAILED SETTING

You can set detailed settings for each color mode.

### 1

When the target color mode is selected from the list at the bottom of the screen, press the **AEL** button to move to the Color menu screen.

### 2

Set the intensity of effect or detailed information following the item in [Color Mode] (P.91).

### 3

To return to the color mode BKT screen, press the **MENU** button once or twice.

## Fill Light BKT



---

This function allows you to continuously take photographs with the Fill Light effect increased or reduced based on an image with no Fill Light effect applied.

<b>Bracketing Number</b>	Number of shots (three or five)
<b>Bracketing Amount</b>	In 0.2-step increments up to $\pm 5$ EV



**4**

Use the  buttons to select a desired value, and press the  button or the  button to apply the setting.

**5**

Half-press the shutter button to return to the shooting mode. (The setting icon and bracketing amount are displayed.)

### CAUTION

- The following functions or settings cannot be used in combination.



Color Mode: [Off], [Duotone],
-------------------------------

## HDR (High Dynamic Range)

---

With HDR, you can shoot pictures or movies rich in gradation with reduced overexposed areas and blocked up shadows.

- For still image shooting, three images of standard, underexposure, and overexposure are continuously shot at one time, and they are combined automatically.
- For movie shooting, this system shoots images of different exposure values at double the speed of the specified frame rate, and creates a video while repeating a combination of two images.

In the [ /  SHOOT] menu, select your desired range of exposures from [HDR].

<b>Off</b>	<b>Auto</b>	<b><math>\pm 1.0</math></b>	<b><math>\pm 2.0</math></b>	<b><math>\pm 3.0</math></b>
------------	-------------	-----------------------------	-----------------------------	-----------------------------

- [Auto] is the setting in which the camera automatically determines a range of exposures.

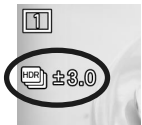

- In CINE mode, only On / Off can be set.

When the setting is completed, the setting icon is displayed.

## CAUTION

- HDR will not be canceled automatically. After taking pictures or recording movies, be sure to turn the HDR back to [Off].
- In STILL mode, an image is recorded at a narrow angle of view of approximately 5%.
- For still image shooting, an image misalignment may occur when the subject is moving rapidly or when the shutter speed is slow.
- For movie shooting, an image misalignment may occur when the subject is moving rapidly or when zooming or focus movement occurs.
- For movie shooting, the selectable range of shutter speeds and the working range become narrow.
- The following functions or settings cannot be used in combination.

Drive Mode: Continuous, Interval Timer, Flash photography,  
Color Mode: [Off], [Duotone], Electronic Stabilization, Fill Light,  
ISO sensitivity settings added with the [Composite Low ISO Expansion],  
ISO sensitivity settings added in [High ISO Expansion],  
Image Quality: DNG, DNG+JPEG, Format: CinemaDNG, Bracketing

- This function cannot be used when CINE mode format is [MOV] and in the following settings.

	119.88fps ~ 48fps	29.97fps ~ 23.98fps
UHD	X	X
FHD	X	O

O: Available X: Unavailable

## CUSTOM MODE

Registering your preferred settings allows you to recall these settings easily by the Mode button. (Up to six patterns can be registered.)

You can register all items in the [📷/👤 SHOOT] menu (blue tab).



## SAVE THE CUSTOM MODE

---

**1**

Set the settings in [ / SHOOT] (blue tab) to your desired combination.

**2**

Select [ SYSTEM] → [Custom Mode Setting], and press the <> buttons to select **C1**, **C2**, **C3**, **C4**, **C5**, or **C6**. Then, press the button. A confirmation dialog will appear.

**3**

Select [**Yes**] with the <> buttons and press the button to apply the setting.

To cancel, select [**No**] and press the button.

### CAUTION

- When the new setting is saved, the previous stored setting will be overwritten.

## LOAD THE CUSTOM MODE

---

Press the Mode button and set to **C1**, **C2**, **C3**, **C4**, **C5**, or **C6**.

- The exposure mode can also be set by selecting [ / SHOOT] → [Exposure Settings] → [Shooting Mode].
- Press the AEL button on the Shooting Mode Change screen to go into the detailed settings for Custom mode, where you can change the icon or name of Custom mode or temporarily change the exposure mode.



If the setting is changed in custom mode, the ● mark is shown.

### Return to original registered setting by doing the following.

- Turn the camera off (this includes the camera turning off automatically with the Auto Power Off function)
- Press the Mode button and set to another position.

## CHANGING THE ICON OR NAME OF CUSTOM MODE

You can change the [Icon] or [Name] of Custom mode by pressing the **AEL** button on the Mode Change screen.

- Once the icon or name is changed, the changed icon or name will appear in a live view or on the Shooting Mode Change screen.
- The icon and name will not be reset when the camera is turned off.

## CHANGING THE ICON

Specify two characters for [Icon] on the entry screen.

For example, if you want to name the icon "S2", type **S** and **2** and press the **OK** button to apply your change.

- Supported characters are alphabet characters (upper case only), digits, and symbols (#, -, ±, and +).
- If you want to initialize the icon, press the **MODE** button and then press the **OK** button to confirm.



## CHANGING THE NAME

Enter appropriate characters for [Name] on the entry screen. For details on how to enter characters, refer to [ENTERING INFORMATION] (P.143) in [COPYRIGHT INFORMATION].

- If you want to initialize the name, delete all characters on the entry screen.

## SAVE / LOAD SETTINGS

You can save camera settings as QR code images or load camera settings from QR codes. You can easily share recommended settings for the camera with other users.

All items in [ /  **SHOOT**] (blue tab) and part of the items in [ **SYSTEM**] can be saved and loaded.

## SAVING SETTINGS

---

Save the current camera settings on a memory medium as a QR code.

[ **SYSTEM**] → [Save / Load Settings ] → [Save to QR Code].

## ENTER AN ICON AND NAME

For **[Icon]** or **[Name]** on the entry screen, set an icon and name for the setting you want to save in a QR code (see P.143).

- The icon and name you set will be applied to Custom mode when the settings are read from the QR code.
- If the current shooting mode is a custom mode, an icon for that mode is entered by default. Otherwise, the current shooting mode is entered after a hash (#) symbol.
- If the current shooting mode is a custom mode, a name for that mode is entered by default. If no name has been set or the current shooting mode is PASM, "My Settings" appears.

## SELECTING SETTINGS TO SAVE

For **[Settings to Save]** on the entry screen, select the settings you want to save. Point the cursor at each of the settings and use the **<>** buttons to check (✓) or uncheck (✗).

- Checked (✓) items are saved and unchecked (✗) items are not saved.
- All blue tabs are checked (✓) by default.
- Each time you press the **MODE** button, Check All Items changes to Uncheck All Items or vice versa in the tab you are viewing.
- The settings for both STILL and CINE modes are saved regardless of the current switch position.

## CREATING AND SAVING QR CODES

#P  
My Settings  
SHOOT 1 2 3 4 5 6  
  
SIGMA fp L Ver:1.00  
2021/04/04 11:19:44

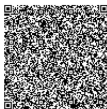

When you position the cursor at the top of the **[Save to QR Code]** screen and press the **>** button or **OK** button, the **[Save QR Code]** screen is displayed. Press the **OK** button to save the QR code image on a memory medium.

SIGMA

- The QR code image contains information such as the icon and name for the recorded settings, tabs for the saved settings, camera model name, firmware version used by the camera, and dates and times when the settings are saved. Make use of it to identify what is recorded.
- The handling of file names and playback of QR code images is the same as for captured images in the screenshot feature. Refer to **[SCREENSHOT FEATURE]** on page 157.

## LOADING SETTINGS

---

You can load the settings from the QR code displayed on a PC monitor into the camera.



[ SYSTEM] → [Save / Load Settings ] → [Load from QR Code].

The camera activates in the QR code loading mode. Display the QR code in full frame. If the camera detects the corresponding QR code, the [Select Destination Mode] screen is automatically displayed.

- Manually focus the camera.
- The Front and Rear Dials allow you to select the display magnification, 1x, 4x or 8x.

### LOADING SETTINGS FROM AN IMAGE STORED ON A MEMORY MEDIUM

Pressing the button in the QR code loading mode displays images saved on a memory medium. Select a QR code image from which you want to load the settings. When a QR code is loaded successfully, the name of settings appears. When you press the button to confirm your selection, the [Select Destination Mode] screen is displayed.

- If a QR code is not loaded successfully from the image, use the Front Dial, up, down, right, or left buttons to adjust the size or position of the QR code displayed on the screen.



On the [Select Destination Mode] screen, select a destination to which the settings will be registered and press the button. A confirmation dialog will appear. Select [Yes] to confirm your selection and press the button. To cancel, select [No] and press the button.

- If the [ SYSTEM] items are included, system settings will be overwritten or a confirmation dialog will appear. If you select [No], the settings excluding the system settings will be loaded.

### CAUTION

- When the new setting is saved, the previously stored setting will be overwritten.

# LOCK FUNCTION

---

This product provides the lock function that locks button operations and allows the user to concentrate on shooting without being bothered by erroneous button operations.

- The lock on/off function must be assigned to the Quick Set menu. Assign [LOCK] in Custom QS (P.37).

## LOCK

To lock, select [🔒 LOCK] in the Quick Set menu, and press the **AEL** button.



While the lock function is active, the 🔒 LOCK icon is displayed at the bottom of the screen.

## UNLOCK

Slide from the left to the right on the touch panel.

Alternatively, press the **QS** button, and then press the **AEL** button.

You can also specify a button you want to enable operation for even while the lock function is active. Select [🔒 SYSTEM] → [Operation in LOCK Mode] to specify the target operation.

 +REC button	The shutter button and REC button are available.
 +REC button	The shutter button, REC button, and Front/Rear dial are available.

# USING THE EXTERNAL FLASH

---

Optional Sigma Electronic Flash EF-630 (FOR SIGMA) with the S-TTL system allows you to use features such as Auto Flash with this camera. The Electronic Flash EF-630 (FOR SIGMA) lets you do even more, such as use Multi Flash and other advanced features.

## CAUTION

- When using the flash, attach the hot shoe unit HU-11, which is supplied with this product, to the camera (P.19).

- This product does not support the FP flash function and Dedicated receive & flash function.
- The following functions or settings cannot be used in combination.

Drive Mode: Continuous, Interval Timer, Electronic Stabilization, ISO sensitivity settings added with the [Composite Low ISO Expansion], HDR, Exposure BKT, Focus BKT

- The flash tuning speed is set to 1/30 sec. or less (1/15 sec. or less when the image quality is set to DNG and DNG + JPEG and the memory bit count is 14 bits). When shooting with the flash using manual exposure, set the shutter speed to 1/30 sec. or less (1/15 sec. or less).

## FLASH MODE SETTING

Some items of the external flash can be set from the camera side.

To set the flash mode, select [ SHOOT] → [Flash].



### RED-EYE REDUCTION FLASH (Red-eye)

When taking a picture with a flash, sometimes the person's eyes reflect the flash light and the "red-eye" phenomenon will appear in the picture. In order to avoid this effect, the light flashes for about one second before the picture is taken to reduce the effect of red-eye.

- Depending on the lighting and subject conditions, the Red-eye Reduction flash may not completely eliminate the red-eye in all cases.



### REAR CURTAIN SYNCHRONIZATION (Rear Curtain Sync.)

When you use rear curtain synchronization, the flash will fire just before the rear curtain begins to close and the subject will be exposed to ambient light from the time the shutter opens until the flash fires. As a result traces of the subject will be recorded behind the subject. This gives a more natural effect.



### SLOW SYNCHRO MODE (Slow Sync.)

When using the flash with P/A mode, the shutter speed value, which will reduce camera shake, is set automatically. The slow synchro mode changes the shutter speed by up to 30 seconds depending on the lighting conditions. This mode is suitable for shooting portraits and nightscapes.

## AF ASSIST LIGHT (AF Assist Light)

When the AF Assist Light prevents appropriate shooting, disable it by setting [AF Assist Light] to [Off].

### CAUTION

- The Flash Mode cannot be set if a flash is not attached to the camera, or the flash is turned off.

## FLASH EXPOSURE COMPENSATION

It is possible to compensate the flash output level without changing the background's exposure.

To set the Flash Exposure Compensation, select [SHOOT] → [Flash] → [Flash Exposure Compensation].

Select the desired compensation value by using the  buttons.

- Exposure compensation can be set in 1/3 stop increments from +3.0 to -3.0 stops.

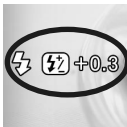

When the setting is completed, the setting icon and compensation value are displayed.

### CAUTION

- The flash exposure compensation can not be set if the flashgun is not attached to the camera, or the flashgun is turned off.
- The flash exposure compensation will not disable automatically. After taking the picture, set the compensation value to  $\pm 0.0$  by above procedure.

# CHANGING OTHER SETTINGS

This section describes other settings that can be configured in the items of [📷/👤 SHOOT].

## COLOR SPACE

### (STILL)

It is possible to select sRGB, which is a common color space or Adobe RGB, which is mainly used for commercial printing, and other industrial purposes.

[📷 SHOOT] → [Color Settings] → [Color Space].

sRGB (Default)	AdobeRGB
----------------	----------

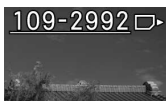

When reviewing images recorded in Adobe RGB, their Folder numbering / File numbering will be underlined.

### CAUTION

- Please set the color space to sRGB for regular usage. Use the image set to Adobe RGB under the environment compatible with Adobe RGB.

## LENS FUNCTION SETTINGS

The lens function items are compiled in [Lens Function Settings] of [📷/👤 SHOOT].

Focus Mode (Refer to P.51.)	Optical Stabilization (Refer to P.66.)
Focus Limiter (Refer to P.57.)	AFL Button Settings

### AFL Button Settings

You can customize the AFL button functions of the lens equipped with the AFL button.

AFL (Pressed) (Default)	If you press the AFL button while AF mode is active, AF mode stops.
AF-ON	If you press the AFL button, AF mode is activated.



## SHUTTER BLACKOUT

### (STILL)

Set whether or not to display a black image on the screen when the shutter button is pressed.

<b>Off</b>	<b>On (Default)</b>
------------	---------------------

## FRAME GUIDE



### (CINE)

A frame guide that is useful for determining the composition can be displayed when shooting with different aspect ratios is taken into account.

- You can set whether or not to show the frame guide in [**Frame Guide**] in [] **DISPLAY MODE SETTINGS**] (P.146).
- Frame Guide can be viewed when using Director's Viewfinder.
- Multiple frames can be displayed simultaneously. Set the option you want to display to [**On**].

<b>1.33 : 1</b>	<b>1.85 : 1</b>	<b>2.39 : 1</b>
<b>Custom Frame 1</b>		<b>Custom Frame 2</b>

- A display style can be set for each guide. Set a display style from [**On**].

<b>Style</b>	<b>Color</b>
<b>Line</b>	<b>Shading</b>

### Style

<b>Full Box</b>	<b>Top / Bottom</b>
<b>Corners</b>	<b>Left / Right</b>

### Line

Lines of between one and 10 pixels can be specified.

## CAUTION

- Depending on the setting conditions, it may not be displayed with the specified number of pixels.

### Color

<b>White</b>	<b>Red</b>	<b>Green</b>	<b>Blue</b>
<b>Black</b>	<b>Yellow</b>	<b>Cyan</b>	<b>Magenta</b>

### Shading

Darkly masks an area outside a frame in Semi-Transparent mode.

<b>Off (Default)</b>	<b>On</b>
----------------------	-----------

### Custom Frame

A custom frame can be displayed by entering any aspect ratio or absolute size value on the image sensor.

Select [**Custom Frame 1**] or [**Custom Frame 2**], select [**On**], and then set a custom frame.

- Select an input method from [**Input**] in the [**FORMAT**] tab.

<b>Sensor Area</b>	Specify the size on the image sensor to display the frame guide.
<b>Aspect Ratio</b>	Specify any aspect ratio to display the frame guide.

### Input in [Sensor Area]

For [**Width / Height**] on the entry screen, specify the width and height.

For example, to display a frame guide 20 mm wide and 10 mm high, enter "**20.00 x 10.00 mm**", and press the **OK** button to confirm your entry. The aspect ratio of the frame guide is displayed as **2.00:1** on the setting screen.

- The maximum value of the image sensor when shooting a movie is 35.64 wide and 20.05 mm high.
- The frame guide can be resized while maintaining the aspect ratio of the entered values. For [**Aspect Ratio / Scaling**] on the entry screen, specify the percentage (1 to 100%). For example, to change the size from 20.00 x 10.00 mm to 10.00 x 5.00 mm, enter **50%** and press the **OK** button to confirm your entry.
- The aspect ratios can be readjusted for [**Aspect Ratio / Scaling**] on the entry screen.

- The values readjusted for [**Aspect Ratio / Scaling**] on the entry screen will be reset when a change is made in [**Width / Height**] again.
- The display range of the frame guide changes in Director's Viewfinder.

### Input in [**Aspect Ratio**]

Specify an aspect ratio for [**Aspect Ratio**] on the entry screen.

- The standard aspect ratio for movies is 16.00:9.
- Frame guides wider than 16.00:9 are fitted crosswise, and frame guides taller than 16:9 are fitted lengthwise.

### TIP

- The center of the frame guide of a custom frame can be offset. Specify the direction in which to offset the center and how far to offset it for [**Offset**] on the entry screen in the [**OFFSET**] tab.
- The display style can also be set for the frame guide of a custom frame. To set the display style, set the appropriate option in the [**STYLE**] tab.

## DIAL SETTINGS

You can assign the dial function or reverse the dial operation.

Dial Functions	Dial Rotation
Disable Dial Functions (CINE)	

### Dial Functions

This function enables you to reassign the Front and Rear Dials in each exposure mode.



#### 1

Select the exposure mode and a dial you want to change, and press the **OK** button to apply the change.

#### 2

Use the **<>** buttons to select the function you want to assign, and press the **OK** button to apply the setting.

- To return to the default, select the function that you want to return to its default setting and press the **MODE** button, then press the **OK** button to apply your choice.

- This function enables you to switch the Front and Rear Dials. Select the  icons for the exposure mode you want to switch, use the  buttons to switch them, and press the **OK** button to confirm your choice.
- If you want to assign a function in CINE mode (CINE STYLE), set **[Disable Dial Functions]** to **[Off]**.

## Dial Rotation





This function enables you to reverse the dial operation direction when shooting.

Select the target item. Then, press the  buttons to select **[Original]** or **[Reverse]**, and press the **OK** button to apply the setting.

## CUSTOM BUTTONS FUNCTIONS

Any function can be assigned to the following buttons as custom buttons.

AEL (P.86)		 (Directional buttons)	
<b>tone</b>	<b>color</b>	<b>mode</b>	

- **[Quick Focus Frame Shift]** in  is a function that enables you to directly move the focus frame (the multi-point measurement area frame when the camera is in Multi Auto Focus Points mode) using the  buttons. Set it to **[On]** to use it.
- For functions that can be assigned to directional buttons and begin with "Quick", you can directly select options using the  buttons or  buttons.

## CAUTION

- A button to which a function that is dedicated for STILL mode will not be available in CINE mode. A button to which a function that is dedicated for CINE mode will not be available in STILL mode.

## SHUTTER BUTTON SETTINGS

You can change the function or behavior of the shutter button when it is half-pressed.

<b>Shutter Button Functions (CINE)</b>	<b>Half-pressed AEL (STILL)</b>
<b>Half-pressed AF-ON</b>	

### Shutter Button Functions



You can change the function of the shutter button in the CINE mode.

<b>Off</b>	<b>Shutter</b>	<b>REC (Default)</b>
------------	----------------	----------------------

### Half-pressed AEL

#### (STILL)

Select whether or not to fix the exposure when the shutter button is half-pressed.

<b>Off</b>	The exposure will be determined when depressing the shutter button.
<b>On</b>	The exposure will be locked when the shutter button is pressed "half-way".
<b>AF  Only (Default)</b>	Only when Autofocus Mode is set to <b>AF </b> , the exposure is fixed when the button is half-pressed.

### Half-pressed AF-ON

It is possible to select whether or not to operate AF mode when the shutter button is half-pressed.

<b>Off</b>	<b>On (Default)</b>
------------	---------------------

## REC BUTTON SETTINGS

#### (STILL)

You can prevent the REC button from being activated in STILL mode.

<b>Off (Default)</b>	<b>REC</b>
----------------------	------------

# REVIEWING AND DELETING IMAGES

## VIEWING ONE IMAGE AT A TIME

Press the  button to display an image on the LCD monitor.

- For a movie file, the first frame is displayed.
- A cinemagraph is looped for playback.

### Display Date and Time (still image)





### Display Image Info (still image)



1	Number of Pixels
2	Image Size
3	Aspect Ratio
4	Image Quality
5	Folder numbering - File numbering
6	Memory Media
7	File number / Total files recorded

8	Date
9	Time
10	Shutter Speed
11	F Number
12	Exposure Compensation Value
13	ISO Sensitivity

### DURING SINGLE-IMAGE PLAYBACK:

- Rotate the Rear Dial to display the previous or next images.
- Display the previous or next image by pressing the   buttons or flicking (dragging) right or left.
- Press the  button to change the display mode (P.39).

## TIP

- To scroll through images more quickly, press and hold the **◀▶** buttons. Images will advance automatically until the button is released.
- The first and last recorded images on the card are linked. Pressing the **◀** button while the first image is displayed brings up the last recorded image on the card. Pressing the **▶** button while the last image is displayed brings up the first recorded image on the card.
- If there are no images on a memory medium, the error message **"No files on memory media."** will be displayed.
- When reviewing images, if the **▶** button is pressed or the shutter button is pressed halfway, the camera will be changed back to the shooting mode.

## CAUTION

- This camera may not be able to display images captured by other cameras, or images captured by this camera that have been renamed or moved from the DCIM folder on the card.

## MAGNIFYING IMAGES (STILL IMAGES ONLY)

During single-image playback, rotate the Front dial clockwise, or pinch out on the touch panel.

- Each time the dial is turned, the magnification increases.

1x→1.25x→1.6x→2.0x→2.5x→3.15x→4.0x→5.0x→6.3x→8.0x→10.0x

- Each time you press the **OK** button or double-tap the image on the touch panel, the magnification is toggled between zoomed-in view (10x) and original ratio.

## WHILE IN ZOOMED-IN VIEW:

- Rotate the Front dial counterclockwise or pinch in on the touch panel to reduce an image.
- To move the playback part, press the **◀▶** buttons or flick (drag) on the touch panel.
- Rotate the Rear Dial to display the previous or next images.

## TIP

- Images are magnified based on the position of the focus point during shooting.

## VIEWING NINE IMAGES AT A TIME (CONTACT SHEET VIEW)



Images can be viewed in a "contact sheet" of nine thumbnail images.

While reviewing an image, rotate the Front Dial counter-clockwise.

### WHILE IN CONTACT SHEET VIEW:

- Press the  buttons, or rotate the Rear Dial to select other thumbnail images.
- When you rotate the Front Dial clockwise, the selected thumbnail image is played back.
- When you tap any thumbnail on the touch panel, that image is played back.
- Flick the page on the touch panel to display the previous or next page.

## TIP

- The first and last pages are linked. The first page is displayed after the last page.

## VIEWING IMAGE INFORMATION

You can view detailed information for shooting.

Press the  button several times while playing back a single image.



- The Image Information screen has three pages. To switch pages, press the  buttons or flick up and down on the touch panel.

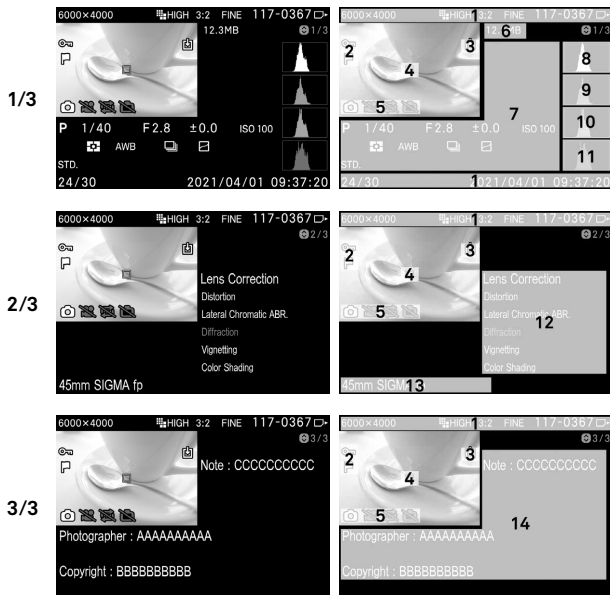

1	Same as single-image playback [Display Date and Time].	8	Histogram (Brightness)
2	Lock / Mark *	9	Histogram (Red)
3	In-camera DNG Development	10	Histogram (Green)
4	Focusing Frame	11	Histogram (Blue)
5	Filtering Options for Display *	12	Lens Optics Compensation
6	File Size	13	Focal Length / Camera name
7	Shooting Information	14	Copyright Information

\* If these features are set, the icon will be displayed.

- When Color mode is set to [OFF], the icon is not displayed.

- For movies, the recorded time appears below File Size.
- For cinemagraphs, the playback time and playback speed appear below File Size.

### IN IMAGE INFORMATION VIEW:

- Rotate the Rear Dial to display the previous or next images.
- Display the previous or next image by pressing the <> buttons or flicking right or left.
- Press the [ ] button to change the display mode (P.39).
- For movies, when you press the OK button or tap [ ] icon on the touch panel, the Single-Image Playback screen appears and a movie is played back.

## MAGNIFYING IMAGES IN IMAGE INFORMATION SCREEN (STILL IMAGES ONLY)



To enlarge an image and view the detailed histogram in a specific area, rotate the Front dial clockwise or pinch out on the touch panel while image information is being displayed.

- Each time you press the OK button or double-tap the image on the touch panel, the magnification is toggled between zoomed-in view (10x) and original ratio.
- For more information on the histogram, see the next section.

### While magnifying the image in the Image Info Screen:

- To move the playback part, press the <> buttons or flick (drag) on the touch panel. Rotate the Front Dial clockwise to increase magnification. Rotate the Front Dial counterclockwise to reduce magnification.
- Rotate the Rear Dial to display the previous or next pages.

## CAUTION

- In zoomed-in view, you cannot move to any other page to display image information.

## HISTOGRAM

---

The histogram is a graphic representation of the distribution of brightness in a picture. The horizontal axis shows the tone values from black (left) through gray to white (right). The vertical axis corresponds to the number of pixels at each brightness level. Accessing correct image exposure can be achieved by examining a histogram of the image.



Underexposure



Correct exposure



Overexposure

To display a histogram in the image information view, the brightness (totalized value of RGB), R (red), G (green), and B (blue) are displayed simultaneously at each level. (The histogram displayed in the shooting mode is the brightness only.)

- You can also use the histogram to determine if zoomed-in sections of an image are over or under exposed.

## DELETING FILES

---

### DELETING A FILE WITH DELETE BUTTON





---

 (Delete) button allows you to delete only the file currently being displayed.

**1**

Select the file you want to delete and press the  button. (The confirmation message, "Delete this file?" appears.)

**2**

Select [Yes] with the   buttons and press the  button to apply the setting. To cancel, select [No] and press the  button.

## CAUTION

- If the file is already locked, the confirmation message, "This file is locked." appears. The file is prevented from being deleted. If you want to delete the file, unlock it. (Refer to pages 127 to 129.)
- Images recorded in DNG+JPG will be deleted along with DNG and JPEG images.

## DELETE FILES FROM THE DELETE MENU

You can delete a single file or multiple files.



Choose your desired option by selecting [▶ PLAY] → [Delete].

<b>Select Files</b>	Select multiple files to delete. Use the ◀ ▶ buttons to display the file to delete, and the ⏪ ⏩ buttons to display the 🗑 icon. Repeat the process to select files to delete.
<b>Current File</b>	Delete the currently selected file only.
<b>All Marked</b>	Delete all marked images on the card. (See P.129-130 for information on marking images.)
<b>All</b>	Delete all files on the card.



Press the OK or ▶ button to confirm your selection. A confirmation dialog will appear.



Select [Yes] by using the ◀ ▶ buttons and press the OK button to apply the setting. If you want to cancel to apply the setting, select [No] by using the ◀ ▶ buttons and press the OK button.

## WARNING

- Locked files are not deleted. (See P.127-129 for information on locking files.)
- When [Select Files], [All Marked] or [All] is done, it may take time to finish them depending on the number of files in the card.

# PLAYING BACK A MOVIE



When you press the **OK** button or tap the **▶** icon on the touch panel while a movie file is being displayed, a movie is played back.



Playback lapse time  
00:14:57



Total recording time  
08:46:23

## CAUTION

- It may take a long time to start playback depending on the card you are using, or playback may be interrupted.

## DURING MOVIE PLAYBACK

Button/Dial	Operation
<b>OK</b>	Pause
<b>&gt;</b>	Fast-forward playback
<b>&lt;</b>	Fast-backward playback
Front/Rear dial	Fast-backward playback ↔ Fast-forward playback

The playback speed increases each time the **>** button is pressed or the Front/Rear dial is turned clockwise. (The playback speed decreases each time the **<** button is pressed or the Front/Rear dial is turned counterclockwise.)

## PLAYBACK SPEED

X1→X1.2→X1.5→X2→X4→X8→X16→X32→X64→X128→X256→X512

- In X1 to X2, a movie is played back with sound.
- The speed in backward playback is X1.2 to X512 (sounds are not played back).



## DURING PAUSE MODE

Button/Dial	Operation
<b>OK</b>	Playback
<b>&gt;</b>	Frame-by-frame playback
<b>&lt;</b>	Reverse frame-by-frame playback
Front/Rear dial	Reverse frame-by-frame playback ↔ Frame-by-frame playback

- To show or hide the operation guide, press the  button during movie playback or Pause mode.

## VOLUME ADJUSTMENT



To display the volume setting guide, press the  button while a movie is being displayed. Use the  to adjust the volume, and use the  button to apply the setting.

## STILL IMAGE CAPTURE FROM RECORDED MOVIE FILES

You can create a photo of the desired frame from a movie file.

### 1

Play back a movie, and temporarily stop it in the target frame.

- If you failed to stop in the desired frame, use the  button or the Front/Rear dial in Pause mode to perform frame-by-frame playback.

### 2

Press the  button to select [**Save As DNG**] or [**Save As JPEG**].

- [**Save As DNG**] is only available when [**Format**] is set to [**CinemaDNG**].

### 3

Select [**Yes**], and press the  button to apply the setting.

- The file size varies depending on the setting of [**Resolution**] of the movie file.

<b>UHD</b>	3840 x 2160
<b>FHD</b>	1920 x 1080

- [**Image Quality**] of a file saved with [**Saved as JPEG**] is set to [**FINE**].
- [**DNG Quality**] of a file saved with [**Saved as DNG**] varies depending on the setting of [**Bit Depth**] of a movie file.
- The file number of the created file is assigned to the next number of the last still file in the media, and saved in a sub folder under the DCIM folder.

# OTHER REVIEWING FEATURES

---

## FILTERING OPTIONS FOR DISPLAY

---



You can filter the file types to play back.

To set this option, select [**▶ PLAY**] → [**Filtering Options for Display**].

<b>Display All (Default) OFF</b>	
<b>Still Images Only</b>	<b>Cinemagraph Files Only</b>
<b>Movie Clips Only</b>	<b>Screenshot Only</b>

- Even if display filtering options are set, filtering options are deactivated when images that are prohibited from being displayed are taken.

## LOCK

---

Locking protects files from being accidentally deleted.

### WARNING

- Formatting a card erases locked files. Review card contents carefully before formatting.

### TIP

- Locked files have a "read-only" status when viewed on a computer.

## TO LOCK A SINGLE FILE

---

**1**

Display the target file, and select [**▶ PLAY**] → [**Lock**].

**2**

Select [**Lock**] from the sub menu.

### 3

Press the **OK** button or **>** button.



- A key icon  will appear in the file indicating that the file is locked.



### TIP

- If the file is already locked, the menu item changes to [**Unlock**].
- To unlock a locked file, select the locked file and follow the same steps as above.
- The **AEL** button can be set as a shortcut button for locking files (see page 139).

## TO LOCK MULTIPLE FILES

### 1

Choose your desired option by selecting [**PLAY**] → [**Lock**].

<b>Select Files</b>	Select multiple files to lock. Use the <b>&lt;&gt;</b> buttons to display the file to lock, and use the <b>⬇</b> buttons to display  icon. Repeat the process to select files to lock.
 <b>Lock</b>	Locks all marked files on the card. (Refer to pages 129 to 130 for information on marking images.)
<b>Lock All</b>	Locks all files on the card.

### 2

A confirmation dialog will appear when you press the **OK** button.

### 3

Select [**Yes**] with the **<>** buttons and press the **OK** button to apply the setting.

To cancel, select [**No**] and press the **OK** button.

- A key icon  will appear in all locked files.



## CAUTION

- The process of [Select Files], [Lock] or [Unlock] may take time depending on the number of files in the card.

## TIP

- To unlock multiple files, select [Unlock All] or [Unlock] in the Lock Menu.

## MARKING IMAGES

Marking images is a convenient way to identify favorite images, select images to be displayed as a slideshow, or select images to be deleted.

## TIP

- Images marked on the camera remain marked when viewed in **SIGMA Photo Pro**.

## TO MARK A SINGLE IMAGE

1

Display the images you want to mark and select [PLAY] → [Mark].

2

Select [Mark] from sub menu.

3

Press the **OK** button or > button.



- A [Mark] will appear in the marked image.

## TIP

- If the image is already marked, the menu item changes to [Unmark].
- To unmark a marked image, select it and follow the same steps as above.

- The **AEL** button can be used as a shortcut key for marking image (see page 139).

## TO MARK MULTIPLE IMAGES

---

### 1

Choose your desired option by selecting [**▶ PLAY**] → [**Mark**].

<b>Select Files</b>	Select multiple files to mark. Use the <> buttons to display the file to mark and use the ⏏ buttons to display  icon. Repeat this until you have specified files you want to mark.
<b>Mark All</b>	Mark all images on the card.

### 2

A confirmation dialog will appear when you press the **OK** button.

### 3

Select [**Yes**] with the <> buttons and press the **OK** button to apply the setting.

To cancel, select [**No**] and press the **OK** button.

- A key icon  will appear in all marked images.

## CAUTION

- The process of [**Select Files**], [**Mark All**] or [**Unmark All**] may take time depending on the number of files in the card.

## TIP

- Select [**Unmark All**] from the Mark Menu to unmark all marked images on the card.

## ROTATING IMAGES

---

### (STILL)

You can rotate the direction in which images are displayed.

## TO ROTATE A SINGLE IMAGE



---

### 1

Display the image you want to rotate and select [▶ PLAY] → [Rotate].

### 2

Choose the desired rotation direction from sub menu.

 <b>Rotate</b>	Rotates the image 90 degrees clockwise.
 <b>Rotate</b>	Rotates the image 90 degrees counterclockwise.

## CAUTION

- You cannot select the Rotate menu if [Image Rotation] in [▶ PLAY] is set to [Off].

## TIP

- To rotate an image 180 degrees, rotate it twice in the same direction.
- To get an image back into its original orientation, rotate it in the opposite direction.
- The **AEL** button can be used as a shortcut key for rotating images (see page 139).
- Images rotated on the camera will be displayed in their rotated orientation in **SIGMA Photo Pro**.

## TO ROTATE MULTIPLE IMAGES

---

### 1

Select [▶ PLAY] → [Rotate] → [Select Files].

### 2

Use the <> buttons to display the file you want to rotate. Press the ^ button to rotate it clockwise. Press the v button to rotate it counterclockwise. Repeat this until you have specified all of the files you want to rotate.

### 3

A confirmation dialog will appear when you press the **OK** button.

### 4

Select **[Yes]** with the **OK** buttons and press the **OK** button to apply the setting.

To cancel, select **[No]** and press the **OK** button.

## SLIDESHOW

The Slideshow feature allows you to show all images on the card or selected images in an automatic playback mode.

### 1

Select **[▶ PLAY]** → **[Slideshow]** and then choose **[All Files]**, **[Locked Files]**, or **[Marked Files]**.

### 2

Press the **OK** or **>** button to start Slideshow.

To stop in the middle of the slideshow, press the **OK** button.

- A movie or cinemagraph is played back once, and the display moves to the next file.
- If the playback view filter (P.127) is combined, a slide show can be provided using only the specified types of files.

## CAUTION

- When **[Marked Files]** is selected, it may take time to start the Slideshow depending on the number of images to be displayed.

## CHANGING SLIDESHOW SETTINGS

Select **[▶ PLAY]** → **[Slideshow]** → **[Slideshow Settings]** and set options for slideshows.

<b>Duration</b>	<b>2 sec.</b> <b>5 sec.</b> <b>10 sec.</b>	Set the length of time that each image in a slideshow is displayed.
<b>Repeat</b>	<b>No</b> <b>Yes</b>	Set whether the slideshow loops continuously or stops at the last image.

## DNG DEVELOPMENT

Without using a PC, it is possible for the camera to develop JPEG images from images recorded in DNG.

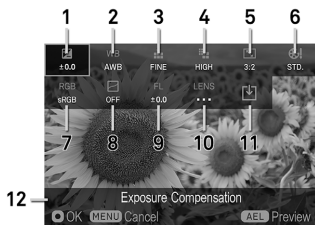

1	Exposure Compensation (P.85)
2	White Balance (P.87)
3	Image Quality (P.70)
4	Image Size (P.71)
5	Aspect Ratio (P.72)
6	Color Mode (P.91)
7	Color Space (P.112)
8	Tone Control (P.94)
9	Fill Light (P.95)
10	Lens Optics Compensation (P.96)
11	Icon to start image development
12	Description of selected icon

### 1

Display the DNG image you want to develop and select [**▶** **PLAY**] → [**DNG Development**].

<b>Select A File</b>	<p>Display an image you want to develop with the <b>&lt;&gt;</b> buttons and press the <b>OK</b> button to confirm your selection.</p> <ul style="list-style-type: none"> <li>It is possible to process [<b>Select A File</b>] even when an image is displayed in Step <b>1</b>.</li> </ul>
<b>Current File</b>	It displays the image selected in Step <b>1</b> .

### 2

In the DNG development setting screen, press the **<>** buttons to select an item you want to change, and press the **OK** button to confirm your selection.

- The details settings are possible depending on items or options. Press the **AEL** button to display the Further Options screen. For details, refer to the related sections in this instruction manual.

### 3

While checking the image, use Front or Rear Dial or  $\langle \rangle$  buttons to change the adjustment value (or option). Then, press the **OK** to accept your change.

### 4

Repeat Step **2** and **3** in case there are multiple items to change.

### 5

After finalizing the setting, select  $\downarrow$  (the Process RAW Development icon) and press the **OK** button.

### 6

Select **[Yes]** with the  $\langle \rangle$  buttons and press the **OK** button to apply the setting.

To cancel, select **[No]** and press the **OK** button.



- At the time of playback, the  $\downarrow$  mark is displayed for the JPEG file created from DNG data.

- The File Number of the JPEG image developed from RAW data will become the next number following the final recorded file in the memory card.

## CAUTION

- If there is insufficient space on the card, a warning message is displayed, and DNG development cannot be performed.
- It is recommended that **SIGMA Photo Pro** is used for further detailed adjustment.

## CINEMAGRAPH

You can create a "cinemagraph" in which only a part of an image is moving, from the exposed movie file.

- A cinemagraph image cannot be created from the movie file recorded in **[Director's Viewfinder]**.

## CINEMAGRAPH EDIT SCREEN

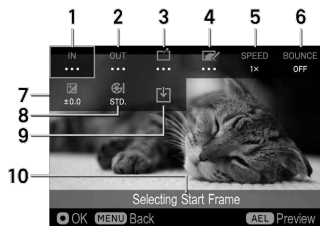

1	Selecting Start Frame
2	Selecting End Frame
3	Selecting Still Image Frame
4	Masking Area
5	Playback Speed
6	Bounce
7	Exposure Compensation
8	Color Mode (Can be set only when the CinemaDNG)
9	Cinemagraph Writing Icon
10	Selected item

### 1

Select [PLAY] → [Cinemagraph] → [New].

### 2

Select a movie you want to create as a cinemagraph, and press the **OK** button. The display changes to the cinemagraph edit screen.



### 3

Specify the starting frame. (Use the **◀▶** button to select **IN**, and press the **OK** button. Press the **▲** button to play back a movie, temporarily stop the movie in the frame you want to start, and press the **OK** button.)

1. Time Code
2. Period of cut-out range

### 4

Specify the ending frame. (Use the **◀▶** button to select **OUT**, and press the **OK** button. In the same way, temporarily stop the movie to end in the target frame, and press the **OK** button.)

- The time length of a movie that can be cut out from a movie varies depending on the frame rate of the original movie.
- If the ending frame is set to a frame beyond the cutout enabled time frame, the starting frame is automatically shifted to make an adjustment.



## 5

Specify a still image frame. (Use the  button to select , and press the **OK** button. In the same way, temporarily stop the movie to be still image in the target frame, and press the **OK** button.)

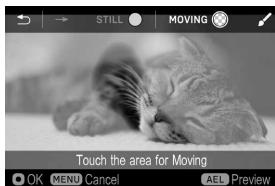
- If you press the **AEL** button during Pause mode, the movie returns to the starting frame.
- If you press the **AEL** button during playback, the movie returns to the starting frame, and stops temporarily.
- A still image frame can also be specified outside the starting or ending frame if it is included in the same file.







## 6

Specify the range to move an image in the specified still image frame. Use the  button to select , and press the **OK** button. Trace the range to move an image with your finger on the touch panel to unmask it (brush work).

## BRUSH WORK

Most of brush work is performed on the touch panel.

- To perform brush work, you can double-tap or pinch out to enlarge the target image. Dragging it with two fingers during zoom-in allows you to move the displayed area.
- Touching  returns the work.
- Touching  redoes the returned work.
- Touching **STILL**  masks the part traced with your finger.
- Touching **MOVING**  unmask the part traced with your finger.
- You can use the **AEL** button to check the effect while working.
- You can use the  button to switch the display/non-display of the guide at the top.

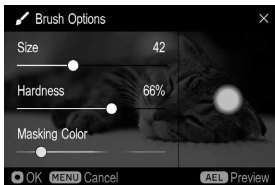

- Touching  shifts to the **[Brush Options]** screen. While viewing the preview screen on the right, drag **[Size]**, **[Hardness]**, or **[Mask Color]** to make adjustments.





When the brush work is completed, press the **OK** button. Configure the following settings as needed.

<b>SPEED</b>	<b>Playback Speed</b>	0.25x to 4.0x (The selectable playback speed varies depending on the frame rate of the original movie.)
<b>BOUNCE</b>	<b>Bounce</b>	[Off] : Not done. [On] : Done.
	<b>Exposure Compensation</b>	Max. $\pm 1$ EV levels in 0.3EV-step increments
	<b>Color Mode</b>	Refer to P.91.



Select (Cinemascope Writing Icon), and press the **OK** button. Select [Yes], and press the **OK** button to apply the setting.

- The cinemagraph format is created with MOV ALL-I regardless of the format of the original movie.
- The resolution of cinemagraph is the same as that of the original movie.
- The frame rate of cinemagraph is set to 23.98, 25, or 29.97 fps depending on the frame rate of the original movie.
- The file number (extension: MOV) of the created cinemagraph is assigned to the next number of the last still image file in the media, and saved in a sub folder under the DCIM folder.
- It takes a long time to write the file. Write processing can be interrupted as needed. While the message "**Now Processing...**" is displayed, press the **MENU** button.
- For data of which the playback time is less than one second, the same image is recorded repeatedly. Consequently, data that is one second or longer is created.

**Even if editing work is interrupted, you can restart from where you left off last time.**

Once a movie file is edited, an editing file with the editing status recorded is created, so it can be re-edited after a work interruption or Cinemagraph writing.



Select **[PLAY]** → **[Cinemagraph]**→**[Edit]**.

## 2

The editing files are previewed. Select a file you want to restart editing, and press the **OK** button.

- Each editing file is identified by the file number, "**Cinemagraph XXX**". (The number is assigned in the range of 000 to 999.)

## TIP

- Such a movie file can be edited as many times as you like unless the original movie file is removed from the media.
- When creating a cinemagraph of another version from the same movie file, begin with **[New]** and then proceed with the subsequent procedure. It is convenient to begin with **[Edit]** when you want to make a minor change (to change the viewing speed).

## DELETING AN EDITED FILE

Delete an unnecessary edited file.

### 1

Select **[▶ PLAY]** → **[Cinemagraph]** → **[Delete Edit File]**.

### 2

Delete the editing file using the same procedure described in **[Select Files]** in **[DELETE FILES FROM THE DELETE MENU]** (P.124).

- The original movie file is not deleted.

## EXPOSURE WARNING

This function displays a red warning for a highlighted part in which a halation occurs on an image due to an overexposure.

Select **[▶ PLAY]** → **[Exposure Warning]**, and set to **[On]**.

- **[Exposure Warning]** is not displayed on the **[Quick Preview]** screen.

## TIP

- The **AEL** button can be assigned to a shortcut key to set **[Exposure Warning]** to **[On]** or **[Off]** (P.139).

## IMAGE ROTATION

This function allows you to change the orientation of an image shot at a vertical position or an image rotated to a vertical position.

To set this option, select [▶ PLAY] → [Image Rotation].

<b>Off</b>	Displays an image at the horizontal position.
<b>On (Default)</b>	Displays an image at the vertical position.

## AEL BUTTON SETTINGS

The playback menu function can be allocated to the **AEL** button. Allocating frequently used functions allows you to perform operations easily using one action.

To set this option, select [▶ PLAY] → [AEL Button Settings].

<b>None</b>	Does not function during playback.
<b>Lock</b>	Lock the currently selected image by pressing the <b>AEL</b> button. If the current image is already locked, the image will be unlocked.
<b>Mark</b>	Mark the currently selected image by pressing the <b>AEL</b> button. If the current image is already marked, the image will be unmarked.
<b>↻ Rotate</b>	Each time the <b>AEL</b> button is pressed, rotate the currently selected image 90 degrees to the right (clockwise).
<b>↺ Rotate</b>	Each time the <b>AEL</b> button is pressed, rotate the currently selected image 90 degrees to the left (counterclockwise).
<b>Exposure Warning</b>	Each time the <b>AEL</b> button is pressed, toggle the exposure warning on or off.
<b>Image Magnification</b>	Each time the <b>AEL</b> button is pressed, toggle between zoomed-in view (10x) and original ratio.
<b>View Filtering Options (Default)</b>	Each time the <b>AEL</b> button is pressed, view filters can be toggled between on and off.

# SETTING FROM THE [SYSTEM] MENU

---

This section describes settings that can be configured in the items of [SYSTEM].

## MEMORY MEDIA FORMAT

---

- Refer to "Card Format" (P.42). (To initialize the USB storage, perform the same procedure as [USB Storage].)

## MEMORY MEDIA

---

When two memory media are set, select the recording or playback target from this item.

SD Card 	USB Storage 
---	---

A data writing failure may occur depending on the USB storage (SSD) you are using. If this happens, changing Write mode may resolve such a failure.

While the USB storage remains connected, select [USB Storage] → [Write Mode], and change the mode from [Standard] to [Custom].

- If [Custom] is set, the  icon is displayed in orange.

## FILE NAME / NUMBER

---

### (CINE/STILL)

The recorded data is assigned to the dedicated file name and file number for both still images and movies.

### (STILL)

#### Still image data (JPEG, DNG)

Folder	Sub folder	File Name / Number
DCIM	100SIGMA	SDIM0001
	⋮	⋮
	999SIGMA	SDIM9999

A file number is followed by the .jpg extension for JPEG data or the .dng extension for DNG data.

## File Name

For the first four characters of the file name, you can select "SDIM" or "FP00".

<b>SDIM****</b> (Default)	<b>FP00****</b>
---------------------------	-----------------

- When [Adobe RGB] is selected in [SHOOT] → [Color Settings] → [Color Space], "SDIM" of the file name is set to "\_SDI", and "FP00" to "\_FP0".

## File Numbering

The file numbering can be changed.

<b>Continuous</b> (Default)	Sequential numbers are assigned. If memory media are changed, numbers will be passed on.
<b>Auto Reset</b>	Once a memory medium is changed or initialized, numbers are reset.

## CAUTION

- When the folder number or file number reaches "999-9999", even if the card or storage has sufficient space, the message [Unable to allocate file number for still images...] is displayed, and it will not be possible to take any more pictures. In such a case, replace the current card or storage with a new one.

### (CINE)

#### Movie data (MOV)

Folder	File Name / Number
<b>CINEMA</b>	A001_001_20210725.MOV
	⋮
	A001_999_20210725.MOV

#### Movie data (CinemaDNG)

Folder	Sub folder	File Name / Number
<b>CINEMA</b>	A001_001	A001_001_20210725.WAV
	⋮	A001_001_20210725_000001.DNG
	A001_999	A001_001_20210725_000002.DNG
		⋮

- CinemaDNG consists of all still DNG data (extension: .DNG) in a sub folder and a single audio file (extension: .WAV). To transfer a file, move the entire sub folder that contains the file.

## Camera ID

"A" (default) to "Z" are assigned to the camera ID.

## Reel Number

"001" (default) to "999" are assigned to the reel number.

## CAUTION

- When the reel number reaches "999", even if the card or storage has sufficient space, the message [**Unable to allocate file number for movie clips...**] is displayed, and it will not be possible to take any more pictures. In such a case, change the camera ID or reel number.

## COPYRIGHT INFORMATION

---

When shooting you can record [**Photographer**] information, [**Copyright**] information, and memo in the Exif data.

- Each item can be entered using up to 48 single-byte alphanumeric characters and symbols.

### 1

On the Copyright Information screen, select [**Photographer**], [**Copyright Owner**], or [**Note**], and follow the steps for [**ENTERING INFORMATION**] (P.143) to enter a text.

### 2

When text entry is completed, select [**On**] in [**Attach Copyright Information**]. (Copyright information is recorded in each image from subsequent shooting.)

## TIP

- The recorded information can be viewed on the image information screen 3/3 (P.120).
- You can review the recorded information in the Image Information Window of **SIGMA Photo Pro** and by EXIF-compatible software.

## CAUTION

- Make sure that [**Attach Copyright Information**] is set to [**Off**] if the camera is being used by another photographer. It is recommended that the information in each entry item is deleted in such cases.

- We assume no responsibility whatsoever for any difficulties and/or damages resulting from the usage of copyright information.

## ENTERING INFORMATION

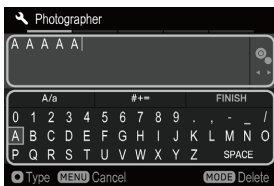

### Entered information area

It is possible to move the cursor in the area using the front/rear dials.

### Keyboard area

Move the cursor in this area using the buttons.



Select the desired character in the Keyboard area, and press the button to enter it.

	Switch the keyboard to alphabet. When the alphabet is displayed, it is possible to select capital and lowercase letters.
	Switch the keyboard to symbols.
	Insert a 1 character space.



Select and to finalize the entered information. It will then go back to the previous screen.

- The **MENU** button will cancel the characters entered, and it goes back to the previous screen.

## Deleting characters

Using the front/rear dials, place the cursor after the letters you wish to delete and press the **MODE** button.

- If you want to insert blank spaces, press the **MODE** button to delete all characters, and then press the button to confirm.

## TIME CODE

### (CINE)

For movie shooting, the time code is recorded automatically. Set the time code to be recorded.

- The time code can also be set from the Quick Set menu in CINE mode (CINE style).
- Whether or not to display the time code on the LCD monitor for shooting can be specified from [TC / Duration] in Display Mode (P.146).

## CAUTION

- This product does not provide the function that synchronizes with an external device.

## Time Code

Set the starting time of the time code.

<b>00 : 00 : 00 : 00</b>	<b>Hour : minute : second : frame</b>
--------------------------	---------------------------------------

- To reset, press the **MODE** button.
- When Count mode is set to [DF] (Drop Frame), the colon, ":", between second and frame is changed to a semicolon, ";".
- The frame numbers that can be set vary depending on the frame rate.

<b>23.98fps</b>	<b>24fps</b>	<b>25fps</b>	<b>29.97fps</b>	<b>48fps</b>	<b>50fps</b>	<b>59.94fps</b>	<b>100fps</b>	<b>119.88fps</b>
0~23	0~23	0~24	0~29	0~23	0~24	0~29	0~24	0~29

- When the frame rate is set to 23.98, 24, or 48 fps, the frame can be only specified using multiples of four.

## RUN Mode

Select the method to count the time code.

<b>REC RUN</b>	Counts only the movie recording time.
<b>FREE RUN</b> (Default)	Counts the total time, including the time in which a movie is unrecorded (including the power-off period).

## Count Mode

Select the method to count the time code.

<b>DF</b>	(Drop Frame) Corrects an error caused due to a drop frame to record a movie.
<b>NDF</b> (Default)	(Non-drop Frame) Does not correct an error caused due to a drop frame to record a movie.



## External Input (TC-IN) (Off / On)

When connecting the time code generator (Timecode Systems UltraSync ONE, etc.), set it to **[On]**.

- Connect the generator to the external microphone terminal. When the generator is connected correctly, the **EX** icon is displayed in the time code display field, and the time code set to the generator is displayed. If the generator is not connected or any connection error occurs, the **EX** icon flashes red.
- Be sure to match the frame rate specified in the movie record setting with the frame rate of the generator. For details, refer to the instruction manual of the generator.

## CAUTION

- When **[External Input]** is set to **[On]**, sounds cannot be recorded.

## HDMI Output (Off / On)

Specify whether or not to output the time code to a device connected using the HDMI cable.

## SHOOTING STYLE

---

### (CINE)

- Refer to page 43.

CINE	STILL-like
------	------------

- Pressing the **➤** button in **[CINE]** enables you to change the settings for **[Shutter Mode]** and **[Disable Dial Functions]**.

## CUSTOM MODE SETTING

---

- Refer to page 104

## CUSTOM QS

---

### (CINE/STILL)

- Refer to page 37.

## DISPLAY MODE SETTINGS

---

### (CINE/STILL)

Size of icon displayed during shooting can be changed, and useful functions to enhance photography can be added.

- The CINE mode (STILL-like style) and STILL mode provide the common settings.

To display options, set the mode (Custom 1 to 4) to customize to [On], and press the **>** button.

- Set the modes that you do not want to display to [Off].

### Font Size

Select the character or icon size.

Normal	Large
--------	-------

### Display Info

You can choose the amount of photography information displayed.

Off	Minimal	Standard
-----	---------	----------

- In any setting, icons related to warnings are displayed.

### Lens Info

#### (CINE)

You can display the information on the lens attached to your camera.

Off	Focus *
Focal Length	Focal Length + Focus *

\* You can select the unit of the shooting distance. Press the **>** button to select the target on the [Focus Distance Scale] screen.

M (Meters)	FEET
------------	------

### Date / Time

You can display the date and time.

Off	Time
Date	Date + Time

## TC / Duration

### (CINE)

Displays the TC (time code) or recording time.

<b>Off</b>	<b>Duration</b>
<b>TC</b>	<b>TC + Duration</b>

## Grid Lines

Grid lines that are useful for determining composition can be displayed.

<b>Off</b>	<b>— 16 (Black)</b>	<b>— 9 (White)</b>
<b>— 4 (Black)</b>	<b>— Diagonal (Black)</b>	<b>— 16 (White)</b>
<b>— 9 (Black)</b>	<b>— 4 (White)</b>	<b>— Diagonal (White)</b>

## Frame Guide (Off / On)

### (CINE)

- Refer to page 113.

## Center Mark

### (CINE)

You can display the center mark that identifies the center of the screen.

<b>Off</b>	<b>Dot</b>	<b>Cross</b>
------------	------------	--------------

## Electronic Level (Off / On)

An electronic level that is useful for determining composition can be displayed.

### ELECTRONIC LEVEL

Camera's horizontal direction and vertical direction are displayed.

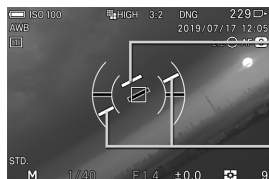

**Vertical direction guide**

**Horizontal direction guide**

- When the camera is horizontal or vertical, the guide becomes green.
- When shooting vertically, the display changes to one for vertical shooting.

## WARNING

- Electronic level usually has error about  $\pm 1^\circ$ . The more it is tilted, the larger the error becomes, and in such case it does not work properly.
- When the camera is facing down, the Electronic level does not work properly.

### Brightness Level Monitor (Off / On)

- Refer to page 49.

### Zebra Pattern (Off / On)

- Refer to page 49.

### Audiometer (Off / On)

(CINE)

- Refer to page 84.

### LCD Off Mode

A mode that turns off the LCD monitor during shooting or when the camera is not being operated. This mode is useful when taking astronomy photographs. When you set [LCD Off Mode] to [On], the mode is added to the display mode.

- The LCD monitor lights up for approximately three seconds when a button or dial is operated while the monitor is turned off.
- When images are being played back, images are being enlarged, the set-up menu is being displayed, or the Quick Set menu is being displayed, the monitor does not turn off.

## OPERATION IN LOCK MODE

---

- Refer to page 109.

## TOUCH OPERATION

---

You can disable operations on the touch panel or change functions that can be operated on the touch panel.

<b>Off</b>	<b>On (Default)</b>
------------	---------------------

- To disable operations on the touch panel, set the Touch Operation to [Off].

- Even if the Touch Operation is set to **[Off]**, touch operations take effect during the following operations that are only performed on the touch panel.

Slide <b>[Lock]</b> to Unlock	Editing of cinemagraphs
-------------------------------	-------------------------

- If you want to change functions that can be operated on the touch panel, set the appropriate function from **[On]**.
- You can change the function for each touch operation. For information about touch operations such as **Tap** and **Double Tap**, refer to **[ABOUT TOUCH OPERATIONS]** (P.27).

### (Settings for shooting)

<b>Tap</b>	<b>Double Tap</b>
------------	-------------------

#### Tap

<b>Off</b>	<b>Touch AF (P.62)</b>
<b>Move Focus Frame</b> (P.53) (P.54) (Default)	<b>(STILL)</b> <b>Touch Shutter (P.62)</b>

#### Double Tap

<b>Off</b>	<b>LV Magnification (P.60) (Default)</b>
------------	--

### (Settings for playback)



#### All Operations

<b>Off</b>	<b>On (Default)</b>
------------	---------------------

- When electronic viewfinder EVF-11 is being used, it is possible to operate the touch panel while looking into the viewfinder. When EVF-11 is attached to the camera, the following options appear.

#### EVF (Settings when using EVF-11)

<b>Tap</b> <b>(Off / On)</b>	<b>Double Tap</b> <b>(Off / On)</b>
---------------------------------	--

- Functions that can be operated while **[On]** is selected conform to  (settings for shooting).
- Functions that can be operated when playing images conform to  (settings for playback).

## ELECTRONIC SOUNDS

---

Set whether or not to use electronic beeping sounds, and adjust their volumes

<b>Shutter Volume</b>	<b>AF Volume</b>
<b>REC Volume</b>	<b>Timer Volume</b>

Select the desired option. To reduce the volume, press the ◀ button, and to increase it, press the ▶ button. Then, press the **OK** button to apply the setting.

- It is possible to set the volume from 0 to 5 in six increments.
- Setting 0 results in no sound.
- The default setting is 3.

## ADJUST ELECTRONIC LEVEL

---

Electronic level's tilt can be adjusted.

Place the camera on a flat, level surface and press the **OK** button. (The new adjustment value is recorded.)

- To reset, press the **MODE** button. A confirmation dialog will appear. Select [**Yes**] and press the **OK** button to apply the setting. (The adjustment value returns to the factory default.)

## PIXEL REFRESH

---

If a bright point is recorded in an image, use pixel refresh. This optimizes shooting elements and image processing.

Close the cap, select [**Yes**], and press the **OK** button to apply the setting.

## LCD SETTINGS

---

You can adjust the brightness and hue of the LCD monitor.

### Brightness (LCD Brightness)

Press the ◀▶ button to adjust to the brightness to the appropriate value, and press the **OK** button to apply the setting.

- When **AUTO** is selected, the monitor is automatically adjusted to an appropriate brightness according to the exposure data.

## Hue (LCD Hue)

Adjust [Red] and [Blue] values while looking at the chart at the bottom of the screen.

- Normally set it to  $\pm 0$ .

## POWER SAVE

---

### LCD Off

The backlight of the LCD monitor is automatically turned off if no operations take place for a certain period of time. Because power is turned on, all buttons are operable. Half-pressing the shutter button starts shooting.

### Auto Power Off

The camera is automatically turned off when no operations are performed while the LCD is inactive. During Auto Power Off, buttons do not work. Half-pressing the shutter button releases the auto power-off mode.

LCD Off Option		Auto Power Off Option	
Off	1 min. (Default)	Off	5 min. (Default)
10 sec.	5 min.	30 sec.	10 min.
30 sec.	10 min.	1 min.	

- It is not possible to set [LCD Off] for a longer time than [Auto Power Off].

### ECO MODE (Off / On)

The LCD monitor is darkened to reduce battery use when the camera has not been operated for eight seconds.

## HDMI OUTPUT

---

### (STILL)

When monitoring a video on the TV or display unit connected using an HDMI cable (sold separately), select whether or not to output icon information with the video.

With Info	Without Info
-----------	--------------

- Prepare the commercially-available HDMI cable with the HDMI terminal (Type D (Ver. 1.4)) attached.

## (CINE)

To set **[HDMI Output]** in CINE mode, first select **[Monitoring Output]** or **[Recorded Image Output]** depending on the purpose. Then, press the **>** buttons to select the option.

### Monitoring Output

When monitoring a video on the TV or display unit connected using an HDMI cable (sold separately), select whether or not to output icon information with the video.

#### Information Display

<b>On</b>	<b>Off</b>
-----------	------------

### Recorded Image Output (HDMI Recorded Image Output)

When recording a video on an external recorder connected using an HDMI cable (sold separately), configure the image output setting from this item.

### Output Format

Set the output signal format of a movie.

<b>RAW</b>	<b>4:2:2 8bit (Default)</b>
------------	-----------------------------

### Resolution

Set the resolution (size) of a movie.

<b>DCI 4K</b>	4096 x 2160 This is only selectable when <b>[Output Format]</b> is set to <b>[RAW]</b> . (The frame rate is fixed to 24 fps.)
<b>UHD (Default)</b>	3840 x 2160
<b>FHD</b>	1920 x 1080

### Frame Rate

Set the frame rate (the number of frames per second).

<b>23.98 fps</b>	<b>25 fps</b>	<b>48 fps</b>	<b>59.94 fps</b>	<b>119.88 fps</b>
<b>24 fps</b>	<b>29.97 fps</b>	<b>50 fps</b>	<b>100 fps</b>	

## CAUTION

- Check that the frame rate matches the frame rate setting of the external recorder.



## USB MODE

---

Set the communication method when a USB cable is connected.

<b>Select When Connecting</b> (Default)	This function is selectable when this product is connected to a device. Press the <b>&lt;&gt;</b> buttons to select the target, and press the <b>OK</b> button to apply the setting.
<b>Mass Storage</b>	Set this option to transfer images on an SD card to a computer.
<b>Video Class (UVC)</b>	Set this option to use this product as a Web camera.
<b>Camera Control</b>	Set this option to operate the camera using software compatible with the computer.

## CAUTION

- USB mode cannot be changed while the camera is connected to your computer. Be sure to set the **[USB mode]** you require before connecting it to your computer.

## CABLE RELEASE SETTINGS

---

### (CINE/STILL)

Set operations to use the cable release switch CR-41 (sold separately).

<b>Shutter</b>	Provides the same operations as the shutter button of the camera.
<b>REC</b>	Provides the same operations as the REC button of the camera.

## EVF SETTINGS

---

Configure various settings for electronic viewfinder EVF-11.

- The following options can only be set when EVF-11 is attached to the camera.



Auto Switch to LCD	
Brightness	Touch Operation (P.148)
Headphone Volume	Firmware Update (P.155)

### Auto Switch to LCD

Even if the Monitor selector is left at [EVF], you can play back images and operate menus on the camera's LCD monitor.



Off	It is displayed in the viewfinder for all operations.
On (for PLAY / MENU)	When operating the  button, <b>MENU</b> button, <b>QS</b> button, etc., the LCD monitor of the camera is displayed. (Customizable buttons depend on the function you assign.)

### Brightness (EVF-11 Brightness)

Press the  button to adjust to the brightness to the appropriate value, and press the  button to apply the setting.

- When **AUTO** is selected, the monitor is automatically adjusted to an appropriate brightness according to the exposure data.

### Headphone Volume

Use the  buttons to adjust the volume, and press the  button to confirm.

- [**Headphone Volume**] can be assigned to the Quick Set menu (P.36), dial (P.115), or a custom button (P.116).

## DATE / TIME / AREA

---

- Refer to page 25.

## Language / 言語

---

- Refer to page 24.

## INFORMATION

---

### 1st page

You can confirm the model name, serial number, firmware version, continuous operation time (from the power-on time to the present time), and sensor temperature.

### 2nd page

You can confirm the authentication mark.

- Other authentication marks are displayed at the bottom of the camera, on gift boxes, and in this instruction manual.

## FIRMWARE UPDATE

---

For details on the firmware update status and update method, refer to our website.

[sigma-global.com/en/support/](http://sigma-global.com/en/support/)

## SAVE / LOAD SETTINGS

---

- Refer to page 106.





## RESET SETTINGS

---

Restores camera settings to the default.



Select the desired reset method from [**Reset Settings**].

<b>Reset Capture Settings</b>	All settings in [  /  <b>SHOOT</b> ] are reset.
<b>Reset Play Settings</b>	All settings in [  <b>PLAY</b> ] are reset.
<b>Reset System Settings</b>	All settings in [  <b>SYSTEM</b> ] except [ <b>Date / Time / Area</b> ] and [ <b>Language</b> ] are reset.
<b>Reset All</b>	All settings are reset. (The camera clock will not be reset.)



Select [**Yes**] and press the **OK** button to apply the setting.

To cancel, select [**No**] and press the **OK** button to apply the setting.

# TRANSFERRING IMAGES TO A COMPUTER

---

The images recorded on a memory card in the camera can be transferred to a computer.

Connect the camera to a computer using the supplied USB cable.

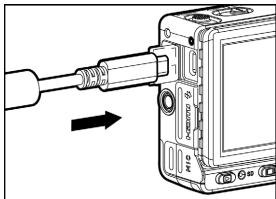

When [**Select When Connecting**] (default) is selected for [**USB Mode**] in [**SYSTEM**], the Select USB Mode screen appears when the camera is connected to a computer. Select [**Mass Storage**]. (Refer to P.144.)

- Using **SIGMA Photo Pro**, you can transfer the images. For details, refer to the **SIGMA Photo Pro** help.
- The camera is recognized as a removal disc (device) by the computer. Therefore, the images can be transferred in a familiar way without using **SIGMA Photo Pro**.

## WARNING

- If the computer enters Sleep mode during processing, the currently transferred data may be damaged. Configure a setting to prevent the computer from entering Sleep mode.
- Please use only the dedicated USB cable that is supplied with this product. Using another cable may cause a failure.
- The Auto Power Off function does not work while the USB cable is being connected.

# USING THIS PRODUCT AS A WEB CAMERA

---

This product can be used as a Web camera.

**1**

Set the CINE/STILL switch to "CINE".

**2**

Connect the camera to the computer using the dedicated USB cable supplied with this product, and set [**USB mode**] to [**Video Class (UVC)**]. (Refer to P.153.)

- If you want to use AF, set [**Constant AF**] to [**On**]. (AF cannot be activated with the shutter button or **AEL** button.)
- For information on the camera or microphone setting, refer to Help or other references of the software you are using.
- To use this product for an extended period of time, it is recommended that you use the AC adapter set (SAC-7P) (sold separately) (P.159).
- Depending on your software, you may need to set a resolution on your camera. If this is the case, set it before connecting.

## CAUTION

- The following buttons are not available.



REC Button,	Shutter Button,	MENU Button,	 Button
-------------	-----------------	--------------	--

- The QS menu can be used, however, unavailable items in the menu are grayed out. In addition, there are some items for which detailed settings are not available.
- The Image Magnification function is not available.

## SCREENSHOT FEATURE

---

Any screen of the LCD monitor can be saved as a still-image file. Screenshots can be used in various ways, such as to capture a set-up menu screen to use in your notes.

On the screen you want to capture, press the  button while holding down the  button. (A white image appears for a second when an image is captured.)

- You can also capture an image by holding down the  button while pressing one of the following buttons.

 Button,	TONE Button,	COLOR Button,	MODE Button
---	--------------	---------------	-------------

- Images through electronic viewfinder EVF-11 can also be captured.
- When captured images are played back, the [**SCREENSHOOT**] icon appears.
- Captured images are saved in an image size of 1024 x 682 and in the JPEG format.
- The name of the file of captured images is "**SS\_XXXX.JPG**".

- Captured image files are saved in folders with regular still images.

## CAUTION

- There may be cases where the number of times images can be captured is limited, or images cannot be captured due to setting status or image processing.
- There may be cases where images cannot be captured in succession when shooting movies.

# REFERENCE

---

This section provides the optional accessories and the camera specifications.

## OPTIONAL ACCESSORIES

---

### **ELECTRONIC VIEWFINDER EVF-11**

---

EVF-11 is a sophisticated electronic viewfinder with a high-definition 3.68 million dot organic EL display (OLED). Although it is an external accessory, it has a unified design. A 90-degree tilt feature increases freedom when shooting. The viewfinder has a headphone jack that enables sound to be monitored. It also has a large eyecup that blocks external light.

### **LCD VIEWFINDER LVF-11**

---

This is a fp/fpL-dedicated viewfinder that magnifies LCD monitor by 2.5x. This function cuts off outside light, so you can easily check the focus or composition even while outdoors. (With base plate BPL-11 attached)

### **ELECTRONIC FLASH EF-630 (FOR SIGMA)**

---

Auto zoom flash with abundant light and STTL Automatic Exposure with the maximum guide number 63/m (207/ft) (ISO100). EF-630 (FOR SIGMA) allows you to use many advanced flash techniques such as “STTL system Auto Flash” or Multi Flash etc.

## **ELECTRONIC FLASH EF-140S SA-STTL**

---

This compact design flashgun has a maximum Guide Number of 14 (ISO100/m). The TTL exposure is controlled by the automatic S-TTL system. This flash unit uses two "AAA" type Ni-MH batteries allowing it to have a compact design.

## **HAND GRIP HG-11**

---

This is an easy-to-handle compact grip that is easy to hold when a small lens is attached. This is considered so that the design matches fp / fp L.

## **HG-21 HAND GRIP**

---

This is a large grip that provides greater operability and that allows the user to hold it securely even when a telephotographic lens such as 135mm F1.8 DG HSM is attached.

## **BASE GRIP BG-11**

---

When it is attached to the camera's tripod socket on the bottom surface of the camera, it allows handgrip-style shooting.

## **AC ADAPTER SAC-7P**

---

This is an AC adapter that can operate the camera using a domestic power supply even if a USB port is not available (for example when a USB storage device is being used). (DC Connector CN-21 is included with this camera.) For details, refer to page 160.

## **BATTERY CHARGER BC-71**

---

This is a charger that is dedicated for the fp / fp L lithium ion charger, "battery pack BP-51". Charging is possible without the camera.

## **CABLE RELEASE SWITCH CR-41**

---

This switch allows you to release the shutter or start REC mode when it is connected to the microphone/cable release terminal of the camera. This switch also provides a microphone jack, so it can be used together with a microphone. (Cable length: Approximately 1m)

## **DC CONNECTOR CN-21**

---

This is an adapter used to connect the camera to a battery manufactured by another company. (This is the same as that supplied with the AC adapter set SAC-7P.)

## USING AC ADAPTER SAC-7P (OPTIONAL)

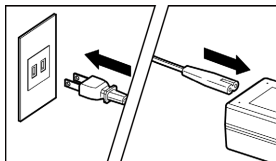

You can power the camera from a wall outlet using the AC adapter set SAC-7P (sold separately).

**1**

Connect the AC cable to the AC adapter.

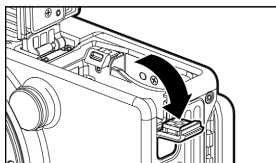

**2**

Open the Battery Cover, and open the DC connector cover as shown in the illustration.

- Do not pull too hard on the DC connector cover as it may come away from camera body.

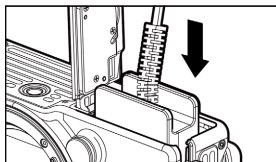

**3**

Insert the DC connector as shown in the illustration until it is locks into place.

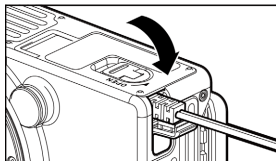

**4**

Close the Battery Cover carefully so as not to pinch the DC connector code.

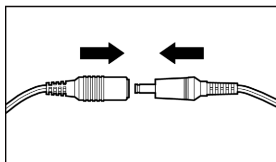

**5**

Connect the plug of the AC adapter and jack of the DC connector.



## WARNING

- When the access lamp is lit, take extreme care to prevent the jack from becoming disconnected. Otherwise, the camera will turn off and the written data will be lost.

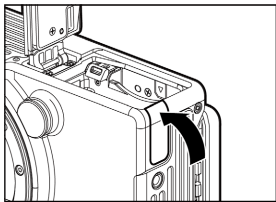

- When you have finished using the camera, please turn off the camera and disconnect the plug from the wall socket.

After taking the DC connector off from the camera body, close the DC connector cover as shown in the illustration.

## MAINTENANCE

---

- Do not use chemicals or other cleaning agents such as thinners or benzene for cleaning the camera and lens. Use a clean, soft cloth and blower to clean the camera and lens. Lens cleaners can be used for removing fingerprints.
- Use a blower to remove dust and dirt from the color LCD monitor. To remove fingerprints or other stains from the LCD monitor, wipe the surface gently with a soft, clean cloth. Do not apply excessive force, as this could damage the LCD monitor.

## CLEANING THE DUST PROTECTOR

---

Blow away any dust on the dust protector (image sensor protection glass) using a blower. If there are any fingerprints on the glass of the dust protector, first blow away any dust using a blower, then gently wipe it using a soft, clean cloth. If any stubborn stains or dust remains, contact our service station for cleaning services.

## WARNING

- Do not use an aerosol compressed air cleaner. Liquid squirts depending on the injection angle, which may damage the dust protector.
- Please do not use the blower with a brush. If a brush is attached, it may scratch the dust protector.

## HOW TO STORE THE CAMERA

---

- If you intend to store the camera for a long time, remove the battery.
- To avoid growth of fungus, store the camera and lens in a dry, cool and ventilated place, with a drying agent such as silica gel. Keep your equipment away from chemicals.

## NOTE ON THE TFT COLOR LCD MONITOR

---

- A few pixels may always be lit or may never light on the LCD monitor. This is not a failure or malfunction. Images recorded with the camera will not be affected.
- Because of the normal physical characteristics of the liquid crystal, the reaction of the display may become slow at low temperatures. At high temperatures, the display may become dark, but it will return to normal at room temperature.

## TROUBLESHOOTING

---

If you have a problem with your camera or cannot take good pictures, consult the list below as you check the camera before requesting repairs.

### **Nothing is displayed on the color LCD monitor.**

---

Battery is exhausted.

- ▶ Replace the battery. (P.20 - 22)

Camera is in LCD Off mode (P.151).

- ▶ Press the shutter button “half-way” or any other button.

### **The shutter does not release.**

---

The camera is busy writing to the card.

- ▶ Please wait until the card busy light goes off.

Card is full.

- ▶ Insert a new card or delete unwanted images. (P.123 - 124)

### **Autofocus does not operate.**

The AF/M switch on the lens body is set to **M**.

- ▶ Set the AF/M switch on the lens to **AF**. (P.51)

Lens is not properly mounted to the camera body.

- ▶ Mount the lens to the camera body correctly. (P.23)

When the [**Half-pressed AF-ON**] is set as [**Off**].

- ▶ Please select [**On**] in the [**Half-pressed AF-ON**] setting. (P.117)

The lens being used is not compatible with auto focusing.

- ▶ Check whether or not the lens is compatible on our website. (P.12)

### **The camera has turned off automatically.**

Auto Power Off is activated.

- ▶ The Auto Power Off function is set in order to conserve battery power. If it is inconvenient, please set the Auto Power Off to "Off". (P.151)

### **Cannot shoot or store images.**

Card is full

- ▶ Insert a new card or delete unwanted images. (P.123 - 124)

Battery is exhausted.

- ▶ Replace the battery. (P.20 - 22)

The write protection switch is in the 'LOCK' position.

- ▶ Please unlock the write protection switch on the card. (P.11)

Image data on the card is corrupted.

- ▶ If important data remains in the card after transferring it to your PC, please format the card. (P.42)

### **Difficulty seeing the images on the color LCD monitor.**

Dust or dirt has adhered to the color LCD monitor.

- ▶ Clean the color LCD monitor with a blower or eyeglass cloth. (P.161)

The color LCD monitor is worn out.

- ▶ Please consult the retailer from which you purchased the camera or contact the nearest Sigma Service Center.

### **Pictures are coming out blurred**

---

AF may not be activated when the shutter was pressed.

- ▶ Press the shutter button “half-way” and press it after the focusing point is illuminated in green. (P.51)

The AF/M switch on the lens body is set to **M**.

- ▶ Set the AF/M switch on the lens to **AF**. (P.51)

Camera shake is occurred.

- ▶ Increase the ISO sensitivity or use a tripod. (P.67)

### **Cannot delete images.**

---

Images may be locked.

- ▶ Unlock the images. (P.127 - 129)

The write protection switch is in the ‘LOCK’ position.

- ▶ Please unlock the write protection switch on the card. (P.11)

### **Incorrect date and time is shown.**

---

Date and time setting may be incorrect.

- ▶ Enter the correct date and time in the Set-up Menu. (P.25)

### **Error Code appears.**

---

It is not possible to continue shooting due to an internal error.

- ▶ Please contact your nearest authorized SIGMA subsidiary / distributor.  
[sigma-global.com/en/world-network/](http://sigma-global.com/en/world-network/)

# SPECIFICATIONS

Type	Type	Interchangeable-lens Mirrorless Type Digital Camera
	Memory Media	SD, SDHC, SDXC memory card (UHS-II supported) , Portable SSD (USB 3.0 connection, USB bus power supported)
	Lens Mount	L-Mount
	Type	35 mm full size (35.9 mm x 23.9 mm) Back-illuminated CMOS sensor
	Camera effective pixels / Total pixels	Approx. 24.6MP / Approx. 25.3MP
	Aspect Ratio	3:2
	Color Filter System	RGB Primary color filter
Image Sensor	Still Image File Format	Lossless compression RAW(DNG) data 12bit, 14 bit, JPEG(Exif2.3), RAW(DNG)+JPEG : recording is possible
	Image Aspect Ratio	[21:9] / [16:9] / [3:2] / [A Size ( $\sqrt{2}:1$ )] / [4:3] / [7:6] / [1:1]
	Recording Pixels (at 3:2 / JPEG) ( ): In DC Crop Mode	HIGH 6,000 x 4,000 (3,840 x 2,560) MED 4,240 x 2,832 (2,736 x 1,824) LOW 3,008 x 2,000 (1,920 x 1,280)
Image Quality Mode (JPEG)	FINE, NORMAL, BASIC	
Crop	Equivalent to approx. 1.5 times the focal length of the lens (for 35 mm cameras)	
Color Space	sRGB / Adobe RGB	
Movie Recording Format Camera Internal Record	Movie Format	CinemaDNG (8bit / 10bit / 12bit) / MOV : H.264 (ALL-I / GOP)
	Audio Format	Linear PCM (2ch 48 kHz / 16bit)
	Record format / Frame rate	3,840 x 2,160 (UHD 4K) / 23.98p, 24p, 25p, 29.97p 1,920 x 1,080 (FHD) / 23.98p, 24p, 25p, 29.97p, 48p, 50p, 59.94p, 100p, 119.88p
	Continuous Shooting Enable Time	Up to 2 hours
	Cinema DNG Memory Media Limitation	SD card (UHS-II) : UHD 8bit 25p or less, FHD 12bit 59.94p or less Portable SSD : UHD 12bit 29.97p or less, FHD 12bit 100p or less, FHD 10bit / 8bit 119.88p or less

Movie Recording Format HDMI External Output	Movie Format	4:2:2 8 bit 12 bit RAW : External recorder record: Atomos Ninja V, blackmagic Video Assist 12G supported
	Audio Format	Linear PCM (2ch 48 kHz/16-bit)
	Recording Pixels / Frame Rate  AF System / Focus Mode	4,096 x 2,160 (DCI 4K) / 24p (RAW) 3,840 x 2,160 (UHD 4K) / 23.98p, 24p, 25p, 29.97p 1,920 x 1,080 (FHD) / 23.98p, 24p, 25p, 29.97p, 48p, 50p, 59.94p, 100p, 119.88p Contrast detection system / Single AF, Continuous AF (with moving object prediction function) Manual Focus
Focus	AF Sensitivity Range / AF Mode	-5EV to 18EV (F1.4 : ISO100) / Multi Auto Focus Points, 49-points Selection mode, Free Move mode, Face/Eye Detection AF mode, Tracking AF mode
	AF Lock	Half-press the shutter button, or press the <b>AEL</b> button (setting change required).
Exposure Control	Other Focus Functions	AF+MF, MF Assist, MF Guide, Focus Peaking, Release Focus Function, AF-ON, Pre-AF, AF during Image Magnification
	Metering System	Evaluative, Spot, Center Weighted Average
	Metering Range	-5 to 18EV (50 mm F1.4: ISO100)
	Still Image Shooting Mode	(P) Program AE (Program Shift capable), (S) Shutter Speed Priority AE, (A) Aperture Priority AE, (M) Manual
	Movie Shooting Mode	(P) Program AE, (S) Shutter Angle Priority AE, (A) Aperture Priority AE, (M) Manual
	ISO Sensitivity (Recommended exposure value)	Base ISO (Still) : ISO 100, 640 (Cine) : CinemaDNG 12bit / HDMI RAW : ISO 100, 3200 MOV/CinemaDNG 10bit, 8bit, HDMI 4:2:2 8bit : ISO 100, 640 Settable range ISO 100-25600 / Expanded sensitivity ISO 6, 12, 25, 50, 51200, 102400
	Exposure Compensation	±5 EV (in 1/3 stop increments) : ±3 EV at movie recording

Exposure Control	AE Lock	Half-press the shutter button, or press the <b>AEL</b> button.
	Exposure Bracket	3 shots / 5 shots stage exposure $\pm 3EV$ (1/3 Step, Standard $\rightarrow$ Underexposure $\rightarrow$ Overexposure) (Sequence changeable)
Image Stabilization System		Electronic system
White Balance		12 types (Auto, Auto (Lighting Source Priority), Daylight, Shade, Overcast, Incandescent, Fluorescent, Flash, Color Temperature, Custom 1, Custom 2, Custom 3)
Shutter	Type	Electronic shutter
	Shutter Speed	30 to 1/8,000 sec., Bulb up to 300 sec.
Drive Modes		Single capture, continuous shooting (High speed: Approx. 18 frames/sec.), (Medium speed: Approx. 5 frames/sec.), (Low speed: Approx. 3 frames/sec.), Self-timer (2/10 sec.), Interval timer
Monitor	Type / Coverage	TFT color LCD, Aspect Ratio: 3:2. 3.15 type, Approx. 2,1M dots / Approx. 100%
	Touch Panel	Electrostatic capacitance system
Flash (when to use external flash)	Flash Mode	S-TTL automatic light control, Manual, Wireless flash, Multi-emission
	Optional Functions	Red-eye Reduction, Slow Synchronization, Rear Curtain Synchronization
	Flash Exposure Compensation	Max. $\pm 3EV$ in 1/3EV-step increments
	Flash Sync. Speed	Max. 1/30 sec. (1/15 sec. or less when the image quality is set to DNG and DNG + JPEG and the memory bit count is 14 bits)
	External Flash Support	Available when the HOT SHOE UNIT HU-11 (supplied with this product) is mounted. (S-TTL, Wireless support, X-sync.)

Color Mode		15 types (Standard, Vivid, Neutral, Portrait, Landscape, Cinema, Teal and Orange, Sunset Red, Forest Green, Powder Blue, FOV Classic Blue, FOV Classic Yellow, Duotone, Monochrome, Off)
Director's Viewfinder	Supported cameras	ARRI : ARRICAM / ARRIFLEX, ALEXA LF / ALEXA Mini LF, ALEXA SXT, ALEXA Mini, AMIRA, ALEXA65, ALEXA XT SOMY : VENICE RED : MONSTRO 8K, HELIUM 8K, DRAGON 6K, EPIC MX 5K, GEMINI 5K, KOMODO 6K
	Frame guide	1.33:1, 1.85:1, 2.39:1, Custom 1, Custom 2
	Custom frame	Input (Sensor Area / Aspect Ratio), Offset, Style (4 styles), Line (1 to 10px), Color (White, Black, Red, Yellow, Green, Cyan, Blue, Magenta), Shading
Other Functions		Save / Load Settings via QR code, Screenshot, Webcam, In-camera RAW development, Still image capture from recorded movie files, Cinemagraph, Fill Light, HDR shooting (Still / Cine) , Still image shooting during movie shooting
Built-in Microphone, Speaker		Stereo microphone, Monaural speaker
Display Language		English / Japanese / German / French / Spanish / Italian / Simplified Chinese / Traditional Chinese / Korean / Russian / Dutch / Polish / Portuguese / Danish / Swedish / Norwegian / Finnish
Interface	USB Terminal	USB 3.1 GEN1 Type-C (supports Mass Storage, Video Class(UVC), Camera Control)
	HDMI Terminal	Type D (Ver. 1.4)
	Remote	Also used as an external microphone terminal.
	Timecode Input	Also used as an external microphone terminal.
	External Microphone Terminal	Ø3.5 mm stereo mini jack (Plug-in power support)
	Headphone Output Terminal	Ø3.5 mm stereo mini jack (can be connected when using the dedicated ELECTRONIC VIEWFINDER EVF-11)
Flash-synchro Terminal		Dedicated terminal (with HOT SHOE UNIT HU-11 (supplied with this product) mounted)



Dust & splash proof structure	Provided	
Power	Power	Li-ion Battery Pack BP-51 Chargeable by USB power feeding. (At camera power-off)
	Number of Recordable Still Images	Approx. 280 images At 23°C, based on CIPA test standard)
External Dimensions	Minutes of Recordable Continuous Shooting	Approx. 70 min.
	Dimensions (W x H x D)	112.6 x 69.9 x 45.3 mm / 4.4 x 2.8 x 1.8 in.
Weight	Weight	422 g (including battery and SD card) 370 g (Camera body only)
	Operating Temperature	32 - 104 °F / 0 - +40 °C
Operating Environment	Operating Humidity	85 % or less (No dew condensation)

\* The specifications are subject to change without prior notice.

### AC Adapter UAC-11

Input: 100V to 240V  $\sim$  50/60Hz 0.25A

Output: 5.0V  $\equiv$  1.8A

### מתאם מתח UAC-11

UAC-11 : דגם

100-240V  $\sim$  50/60Hz 0.25A : כניסת מתח חשמלי

5.0V  $\equiv$  1.8A : יציאת מתח חשמלי

ארץ הייצור : סין

### Li-ion Battery BP-51

Lithium-ion rechargeable battery

Voltage: 7.2V Cell Capacity: 1200 mAh

Made in China

**SIGMA fp**



Tested To Comply  
With FCC Standards  
FOR HOME OR OFFICE USE

**SIGMA CORPORATION OF AMERICA**

15 Fleetwood Court, Ronkonkoma, NY 11779, U.S.A.  
TEL: 631 585 1144

This device complies with Part 15 of the FCC Rules. Operation is subject to the following two conditions: (1) This device may not cause harmful interference, and (2) this device must accept any interference received, including interference that may cause undesired operation.

#### **For customers in the U.S.A.**

##### **Federal Communications Commission (FCC) Radio Frequency Interference Statement**

This equipment has been tested and found to comply with the limits for class B digital devices, pursuant to Part 15 of the FCC Rules. These limits are designed to provide reasonable protection against harmful interference in a residential installation. This equipment generates, uses and can radiate radio frequency energy and, if not installed and used in accordance with the instructions, may cause harmful interference to radio communications. However, there is no guarantee that interference will not occur in a particular installation. If this equipment does cause harmful interference to radio or television reception, which can be determined by turning the equipment off and on, the user is encouraged to try to correct the interference by one or more of the following measures:

- Reorient or relocate the receiving antenna.
- Increase the separation between the equipment and receiver.
- Connect the equipment into an outlet on a circuit different from that to which the receiver is connected.
- Consult the dealer or an experienced radio/TV technician for help.

Use of interface cable is required to comply with class B limits in Subpart B of Part 15 of FCC Rules.

Any changes or modifications to this equipment not specified in this manual may void your warranty.

#### **For customers in the Canada**

This Class B digital apparatus complies with Canadian ICES-003.

Cet appareil numérique de la classe B est conforme à la norme NMB-003 du Canada.



This mark shows that the construction of the product is double-insulated.

Cette marque indique que la construction du produit a une double isolation.



The CE Mark is a Directive conformity mark of the European Community (EC).

#### **SIGMA (Deutschland) GmbH**

Carl Zeiss Str. 10/2, D 63322 Roedermark, Germany

Sales: 06074/865 16 0 Service: 06074/865 16 65 Support: 06074/865 16 88

E-Mail: info@sigma-foto.de

#### **SIGMA CORPORATION**

2-4-16 Kurigi, Asao-ku, Kawasaki-shi, Kanagawa 215-8530 Japan

Phone : 044-989-7430 Fax : 044-989-7451